

# Product Catalogue 2024

Tagging systems, visible and invisible



## 20 years WG GLOBAL

Wow – almost 20 years!

On December 16, 2004, Xiao Hui Yang and I made the decision to establish WG Global in Shanghai. After eighteen years in the Loss Prevention industry, serving as Sales & Marketing Director in the final years, I found the large corporation too inflexible and less customer oriented. Xiao and WG Security Products Inc. already had their own factories in Shanghai and a high-performance product with great potential. I was familiar with the market. We quickly reached an agreement, and 20 years later, we still stand united. WG GLOBAL is entrepreneur-led, engages in customer-centric development dialogues, is flexible, solution-oriented, and upholds handshake quality.

Some outcomes include:

Invisible theft protection,  
 Cost-effective remote maintenance via WiFi,  
 Self-triggering high-security labels,  
 RFID applications produced in-house.

From being mere providers of our own theft protection, we have evolved into a system house for SMART TECHNOLOGY SOLUTIONS:

Video Management Solutions  
 AI-based Video Analytics Solutions  
 Presentation Systems  
 Public Signage Systems  
 Batteryless ESL Systems

We are constantly learning, aiming to collaboratively find practical solutions with our customers that are better, faster, and ultimately more efficient in usage.

Numerous renowned companies, not only in our core countries Germany and Austria but throughout Europe and beyond, have been using WG system solutions. They trust our experienced consultants and project managers or our solution partners in over 60 countries.

A heartfelt thank you for 20 years of trust.

Best regards,



Anton Kaltenleitner  
 Managing Director / Vice President WG Global

A video speaks more than 1000 words. – WG Portfolio in 3 minutes: Link to the video

: <https://youtu.be/0tsKibUxDUE>



## SMART TECHNOLOGY SOLUTIONS

Theft protection with zero false alarms\* and WiFi significantly reduces inventory discrepancies caused by shoplifting and supports sales staff with a secure sales atmosphere, quick handling, and reliable detection. WiFi remote maintenance is possible without additional investment and helps in case a technical or application-related issue arises.

4 Invisible theft protection  
6 WiFi - Floor Guard Hybrid  
9 WiFi - Sky Guard  
12 WiFi - Floor Guard  
15 WiFi - Floor Loop

20 Visible theft protection  
21 WiFi - Premier & Premier Pro Guard  
25 WiFi - Ad Guard & Ad Guard XL

32 WAVE - High Security Theft Protection Labels  
34 WAVE - Band.it Tag  
35 WAVE - Lanyard Tag  
36 WAVE - Pebble Tag  
37 WAVE - Ninja Plus Tag  
38 WAVE - Opener  
41 WAVE - Remote Alarm  
42 WAVE - Product Code Overview

45 Conventional Labels

59 Cash Accessories  
70 System and Alarm Accessories

77 Remote Maintenance





Exclusive security against shoplifting, fully integrated into the store design

## The „WG-Invisibles“:

### Invisible Article Surveillance - Security without intrusive presence

The integration of a theft protection system into the store design should adhere to aesthetic requirements but must primarily comply with physical laws.

We have developed a modular system kit from which we can create the system configuration that will bring the best results in your situation.

Six different system options that can be integrated into the floor, portal, or wall.

Our invisible systems can be found in almost all market segments. In the exclusive fashion sector, image and aesthetics are usually the main reasons, while in supermarkets, space-saving due to the elimination of visible antennas at the exit is the main concern.

Our "Invisibles" can be remotely controlled via WiFi and are compatible with RFID and video surveillance systems.

Consistent securing with 4-alarm or traditional security labels is crucial for success, alongside system performance. Security labels also serve as a deterrent to potential thieves, directly on the merchandise. The deterrent effect can be enhanced by signage on the

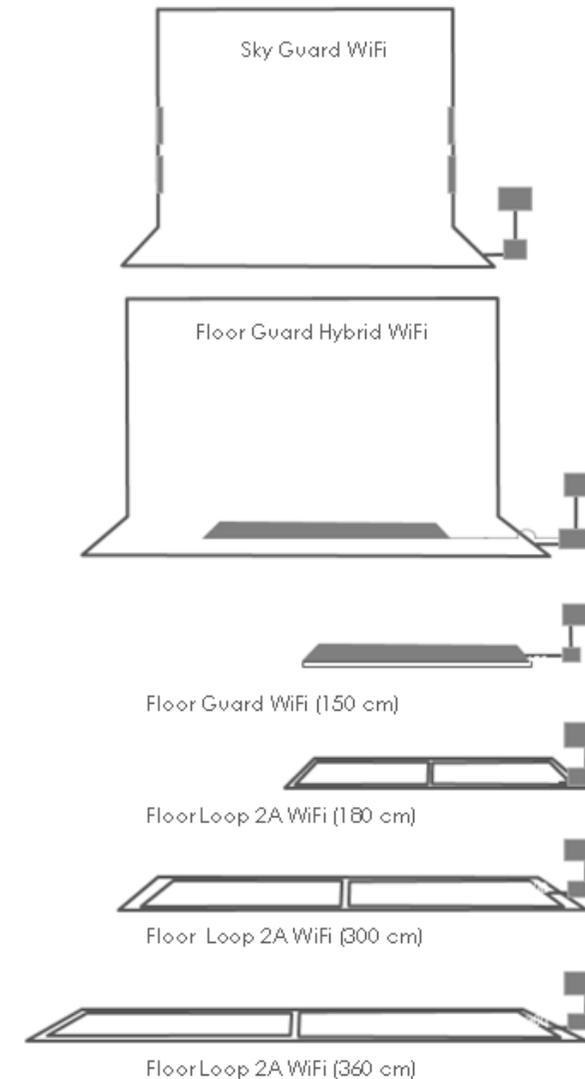



## Floor Guard Hybrid WiFi

False alarm-free\* theft protection with floor and loop antennas.

Invisible solution. With exceptional detection performance, even with the smallest security labels.

**WG**GLOBAL

## Floor Guard Hybrid

### Invisible WiFi-EAS System for smallest security labels.

With FLOOR GUARD HYBRID, nothing compromises the impact of your store design on the customer. Just as your architect planned and realized it, that's how the customer perceives it. Because FLOOR GUARD HYBRID is completely invisible.

The Floor Guard antennas disappear entirely into the floor, and the Hybrid Loop antenna can be integrated into (non-magnetic) door frames made of stainless steel or aluminum. Despite being invisible, Hybrid is just as secure as conventional, visible systems. With new features, it even surpasses most traditional EAS systems for theft protection. The outstanding detection performance of the Hybrid system allows for the use of all types of security labels, including the smallest adhesive security tags. Floor Guard Hybrid enables remote maintenance via WiFi, without any additional infrastructure costs.

Consistent securing with 4-alarm or traditional security labels is crucial for success, alongside system performance. Security labels also serve as a deterrent to potential thieves, directly on the merchandise. The deterrent effect can be enhanced by signage in prominent locations and in fitting rooms.



## Floor Guard Hybrid Installation Description

The Floor Guard antenna is installed in a recess prepared in the floor by the construction site. Due to its low construction height of only 28 mm, this is much easier to accomplish than with previous floor antenna systems. The antenna is embedded in screed or casting resin and can be covered with non-metallic floor coverings (stone, wood, carpet, etc.). To protect the antenna from moisture, we recommend synthetic resin screed (e.g., Rhonaston).

The Hybrid Loop antenna generates an additional transmission field processed by the controller. It uses a special cable with a diameter of 8mm and can even be installed in non-magnetic metal frames. A minimum distance of 20 cm - 30 cm must be maintained to larger elements made of magnetic steel (e.g., gypsum partitioning or steel beams).

The two ends of the Hybrid Loop are connected in an electrical junction box, and a twisted lead of max. 2mm is led to the adapter box. A 32mm empty conduit with draw wire for the antenna cables should be prepared on-site.

The floor antenna and loop must not be framed with electrically conductive metal. Door frames and any intended metal boundaries of the clean walkway zone above

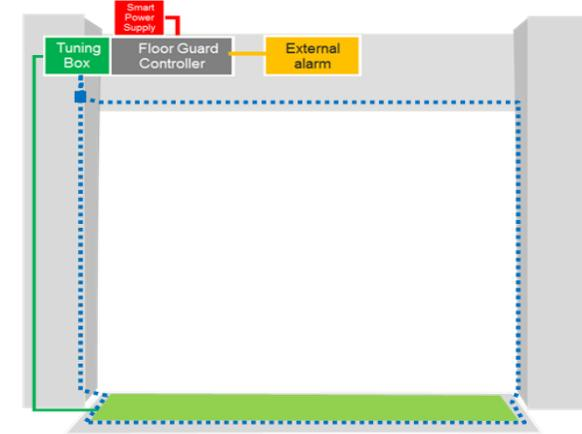
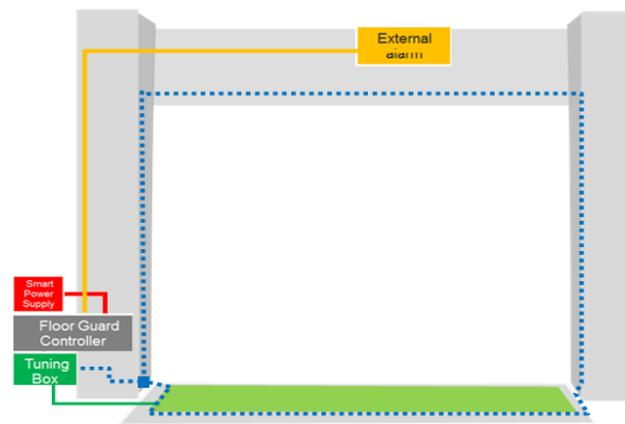

the floor antenna must not form a closed circuit to exclude the effect of a Faraday cage with negative influences on the signal field. This can be achieved, for example, by a cut (1mm) in a shadow joint. Reinforcement metal in the floor can affect the transmission field.

The antenna signals are processed in the tuning box. The twisted (<2m) connection cable of the loop antenna is led from the connection point to the adapter box. Similarly, the connection cable (<6m) of the floor antenna. A system cable (<15m) connects the adapter box and the controller:

The controller is powered by 24 V low voltage. The power supply unit (SPS) and controller are mounted on a mounting plate, but the SPS can also be mounted remotely up to 30 m away. It is then supplied via a six-pole cable

(EAS-Net - 6x0.75mm). It is often installed, for example, in a switch cabinet, on the cash desk, etc., accessible to personnel. The SPS power supply unit has connection terminals for relay contacts to control a camera system in case of an alarm. Alarm volume can be adjusted at the SPS or troubleshooting functions can be used.

An external alarm device above the exit is advisable. It is supplied with a 2-pole alarm cable or CAT cable.

The SPS has a bracket for standard DIN rail mounting on the back. A 32mm empty conduit with draw wire for the antenna cables should be prepared on-site.

For remote maintenance, the controller only needs WLAN access. No additional hardware or software is necessary.



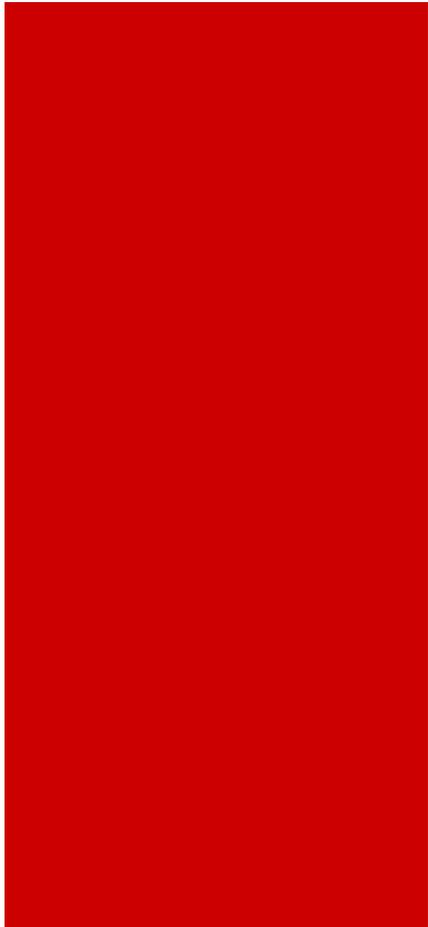

## Sky Guard 4 WiFi

False alarm-free\* theft protection with Turbo and Loop antennas.

Invisible solution. With exceptional detection performance, even with the smallest security labels.

**WG**GLOBAL

## Sky Guard 4 WiFi

### Invisible WiFi-EAS System for smallest security labels..

With SKY GUARD 4, nothing compromises the impact of your store design on the customer. Just as your architect planned and realized it, that's how the customer perceives it.

Because Sky Guard 4 is either completely invisible or as discreet as you want it to be.

The entire Sky Guard surveillance technology can be fully integrated into the portal in new construction or discreetly mounted or partially integrated in an existing portal. Integration into automatic doors is also possible. This allows you to even gain sales space compared to conventional theft protection antennas.

Sky Guard is invisible, but just as secure as conventional, visible systems, and is superior to most traditional EAS systems for theft protection due to additional features.

Like Floor Guard Hybrid, Sky Guard also allows for the use of all types of security labels, including the smallest adhesive security tags. Sky Guard 4 is WiFi-enabled to enable remote maintenance without additional infrastructure costs.

Consistent securing with 4-alarm or traditional security labels is crucial for success, alongside system performance. Security labels also serve as a deterrent to potential thieves, directly on the merchandise. The deterrent effect can be enhanced by signage in prominent locations and in fitting rooms.

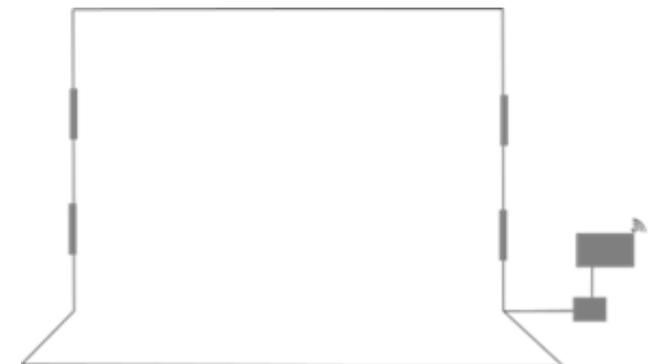

## Sky Guard Installation Description:

Around the door, a transmitting antenna cable (green) is routed. In the floor, the cable is routed in a conduit or groove at approximately 40-50 cm from the edge of the door to achieve slightly earlier detection.

Two Turbo receiving antennas are mounted on the right and left sides of the door at a height of approximately 20-30 cm and 100-120 cm (bottom edge of antennas).

Sky-Guard cables and antennas can be easily and elegantly integrated into an individually painted plastic profile (Sky Guard Frame). For even more customized solutions, the receiving antennas (Turbo antennas) can be covered in wood or plastic but must remain accessible for service and adjustment work. The transmission cable can also be routed in non-magnetic metal (aluminum or stainless steel). However, the four receiving antennas must not be covered by metal.

On-site preparation should include a 32 mm empty conduit with draw wire for the antenna cables.

The transmit loop must be kept at approximately 20 cm from solid magnetic metal elements. If the antenna guide is to be mounted on an existing metal door frame, it must be interrupted at least once by 1 mm to avoid the formation of a Faraday cage with

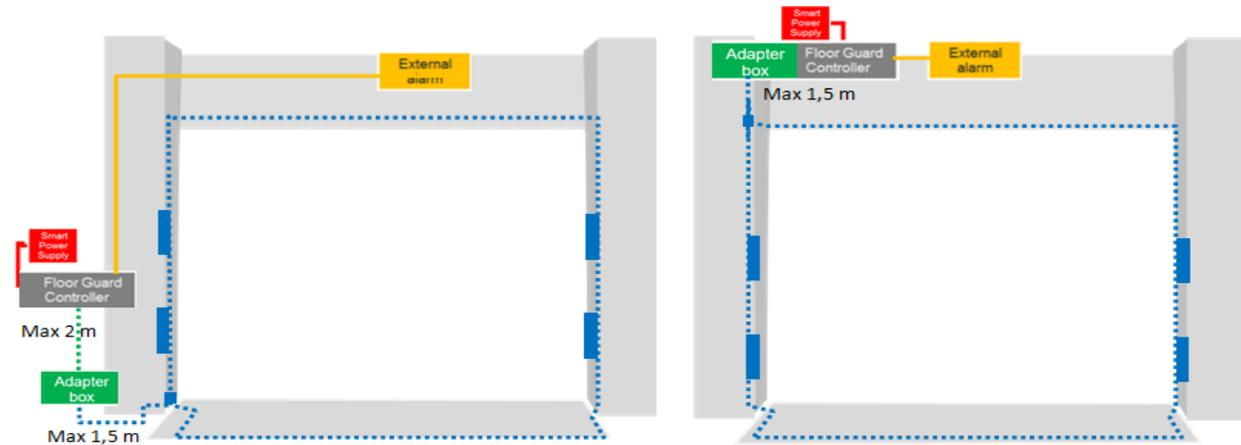

negative effects on the signal field. This can be achieved, for example, by a cut in a shadow joint. The loop and adapter box relate to a twisted cable (<2m).

The floor antenna is connected to a tuning box via a system cable (6 m), which processes the signal and forwards it to the system controller. The box can be positioned, for example, in a service flap in the wall, in the shop fitting, or in the false ceiling. Alarm notification is provided acoustically and visually at the system controller or, if it is installed covertly, at a separate alarm unit.

The controller is powered by 24 V low voltage. The power supply unit (SPS) and controller are mounted on a mounting plate, but the SPS can

also be remotely mounted up to 30 m away. It is then supplied via a six-pole cable (EAS-Net - 6x0.75mm). It is often installed, for example, in a switch cabinet, on the cash desk, etc., accessible to personnel. The SPS power supply unit has connection terminals for relay contacts to control a camera system in case of an alarm. Alarm volume can be adjusted at the SPS or troubleshooting functions can be used. The SPS has a bracket for standard DIN rail mounting on the back.

For remote maintenance, the controller only needs WLAN access. No additional hardware or software is necessary.

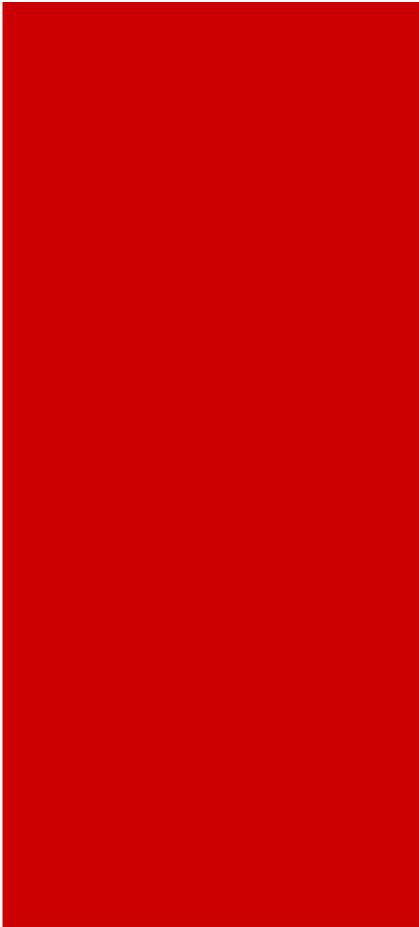

## Floor Guard WiFi

False alarm-free\* theft protection with floor antenna.  
Invisible solution. For unobstructed entrances. Perfect for WG High Sensitivity and



## Floor Guard

### Invisible WiFi-EAS System for any passage width.

With WG Floor Guard, nothing compromises the impact of your store design on the customer. Just as your architect planned and realized it, that's how the customer perceives it.

Because FLOOR GUARD is invisible.

The Floor Guard antennas typically disappear completely into the floor. Thanks to the compact dimensions of 150x40x2.8 cm, Floor Guard antennas can also be integrated into side walls.

This allows passages of any width to be secured, and you gain sales space compared to conventional theft protection antennas.

However, pure floor antenna systems impose higher requirements on security labels. For optimal function and detection height, we recommend using our 4-alarm High Sensitivity security labels or our classic Super Pencil labels.

Floor Guard is invisible, but just as secure as conventional, visible systems, and is superior to most traditional EAS systems for theft protection due to additional features.

Consistent securing with 4-alarm or traditional security labels is crucial for success, alongside system performance. Security labels also serve as a deterrent to potential thieves, directly on the merchandise. The deterrent effect can be enhanced by signage in prominent locations and in fitting rooms.



## Floor Guard Installation description:

The Floor Guard antenna is installed in a recess prepared in the floor by the construction site. Due to its low construction height of only 28 mm, this is much easier to accomplish than with previous floor antenna systems. The antenna is embedded in screed or casting resin and can be covered with non-metallic floor coverings (stone, wood, carpet, etc.). To protect the antenna from moisture, we recommend laying it in synthetic resin screed (e.g., Rhonaston).

Any intended metal boundary of the clean walkway zone must not form a closed circuit to exclude the effect of a Faraday cage with negative influences on the signal field. If such a boundary is planned, interruption can be achieved by a 1mm cut in a shadow joint. A distance of approximately 8 cm - 10 cm must be maintained from solid magnetic metal elements.

The floor antenna is connected to a tuning box via a system cable (6 m), which processes the signal and forwards it to the system controller. The box can be positioned, for example, in a service flap in the wall, in shop fitting, or in the false ceiling. Alarm notification is provided acoustically and visually at the system controller or, if it is installed covertly, at a separate alarm unit.

The controller is powered by 24 V low voltage. The power supply unit (SPS) and controller are

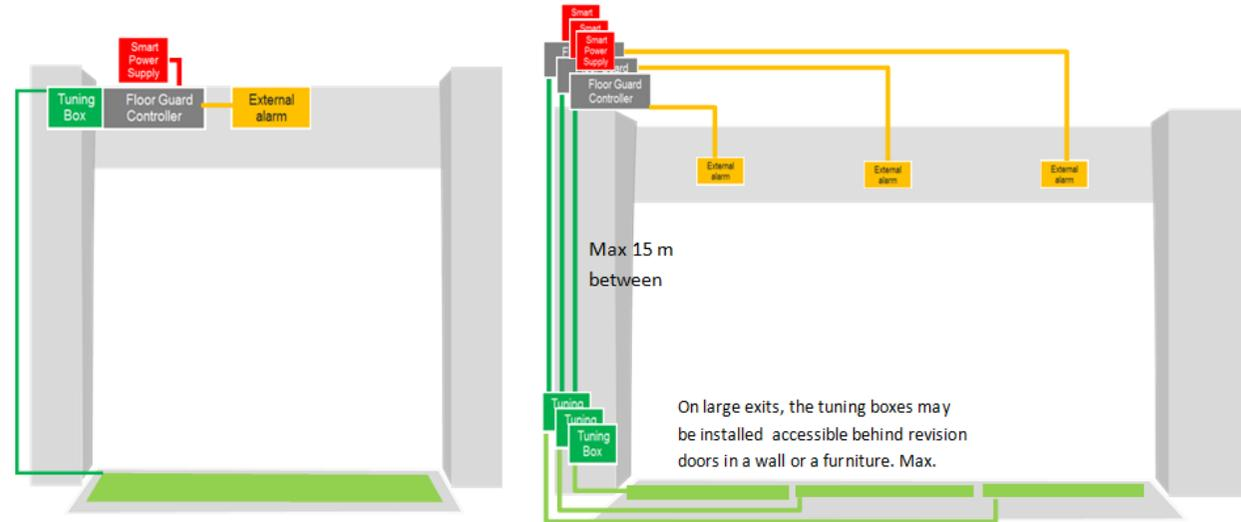

mounted on a mounting plate, but the SPS can also be remotely mounted up to 30 m away. It is then supplied via a six-pole cable (EAS-Net - 6x0.75mm). It is often installed, for example, in a switch cabinet, on the cash desk, etc., accessible to personnel. The SPS power supply unit has connection terminals for relay contacts to control a camera system in case of an alarm. Alarm volume can be adjusted at the SPS or troubleshooting functions can be used. The SPS has a bracket for standard DIN rail mounting on the back.

For remote maintenance, the controller only needs WLAN access. No additional hardware or software is necessary.





## Floor Loop 2a WiFi

False alarm-free\* theft protection with floor antenna.

Invisible solution. For large mall entrances. Perfect for WG High Sensitivity and Super Pencil Labels.

**WG**GLOBAL

## Floor Loop 2a

### Invisible WiFi-EAS system for the widest entrances.

With WG Floor Loop, the largest entrances, such as those in shopping malls, are secured without visible antenna bases or barriers. Nothing compromises the impact of your store design on the customer. Just as your architect planned and realized it, that's how the customer perceives it.

Because FLOOR LOOP 2a is invisible.

The floor antennas are configured on-site and grooved into the floor. Floor Loop is available in three sizes, allowing passages of up to 4 m to be secured with just one antenna. For even larger passages, multiple systems can be used side by side.

Pure floor antenna systems impose higher requirements on security labels. For optimal function and detection height, we recommend using our 4-alarm High Sensitivity security labels or our classic Super Pencil labels.

Floor Loop is invisible, but just as secure as conventional, visible systems, and is superior to most traditional EAS systems for theft protection due to additional features.

Consistent securing with 4-alarm or traditional security labels is crucial for success, alongside system performance. Security labels also serve as a deterrent to potential thieves, directly on the merchandise. The deterrent effect can be enhanced by signage in prominent locations and in fitting rooms.

Image above: Free passage through floor antennas.  
Middle image: Floor Guard antenna before casting..



Image above:  
Unobstructed  
passage through  
floor antennas.  
Middle image:  
Floor Guard  
antenna before  
being embedded.

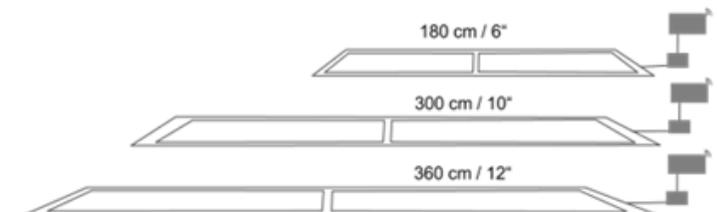

## Floor Loop 2a Installation description:

The Floor Loop antenna is installed in a recess prepared in the floor or grooved into the screed and directly cast. Since the Loop antennas consist only of bundles of cables, they are easily integrable.

The antenna is embedded in screed or casting resin and can be covered with non-metallic floor coverings (stone, wood, carpet, etc.). To protect the antenna from moisture, we recommend using synthetic resin screed (e.g., Rhonaston).

Any intended metal boundary of the clean walkway zone must not form a closed circuit to exclude the effect of a Faraday cage with negative influences on the signal field. If such a boundary is planned, interruption can be achieved by a 1mm cut in a shadow joint. A distance of approximately 8 cm - 10 cm must be maintained from massive magnetic metal elements.

The floor antenna is connected to a tuning box via a system cable (6 m), which processes the signal and forwards it to the system controller. The box can be positioned, for example, in a service flap in the wall, in shop fitting, or in the false ceiling. Alarm notification is provided acoustically and visually at the system

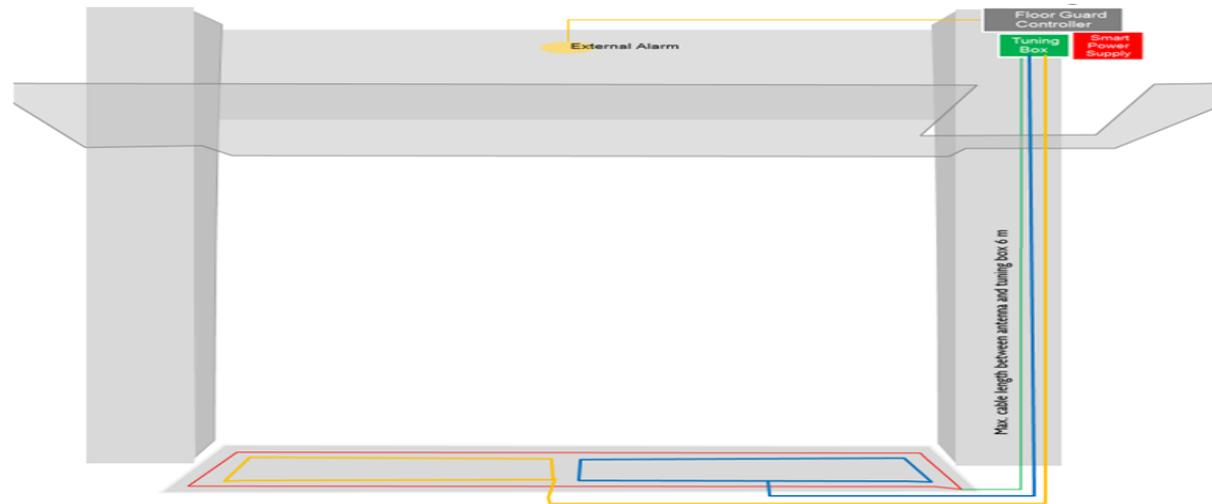

controller or, if it is installed covertly, at a separate alarm unit.

The controller is powered by 24 V low voltage. The power supply unit (SPS) and controller are mounted on a mounting plate, but the SPS can also be remotely mounted up to 30 m away. It is then supplied via a six-pole cable (EAS-Net - 6x0.75mm). It is often installed, for example, in a switch cabinet, on the cash desk, etc., accessible to personnel. The SPS power supply unit has connection terminals for relay contacts to control a camera system in case of an alarm. Alarm volume can be adjusted at the SPS or troubleshooting functions can be

used. The SPS has a bracket for standard DIN rail mounting on the back.

For remote maintenance, the controller only needs WLAN access. No additional hardware or software is necessary.

**Site preparations for invisible systems:**

**Floor Guard / Sky Guard / Floor Loop:**

230 V power supply, independently secured, at the location of the SPS power supply unit.

Maximum consumption 50 W per system, one power socket 230 V 10/120 W (continuous/peak-pulse) per deactivator.

For reliable synchronization, we recommend a fixed connection via terminal box (or reverse-polarity-proof Terko or CEE connectors).

All systems and all deactivators in the building on the same phase (L1 recommended).

PG conduits made of PVC (30 or 32mm) with pull wire for signal lines and loop antenna according to the system diagram.

2-core alarm cable or CAT cable from the system controller to the position of the external alarm console.

Photos: WiFi Control Box with SPS on mounting plate / Adapter Box / Turbo Antenna:

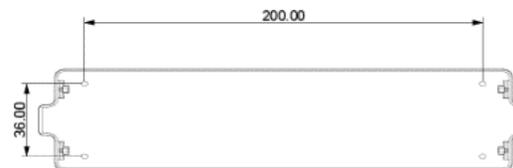

Konfigurationen:		
K WFFG-1 Hybrid	Floor Guard WiFi Hybrid	
K WF SKG4	Sky Guard 4 WiFi	
K WFFG-1	Floor Guard WiFi	
K WFFG-1 WM	WFFG Wandantenne	
K WFFG-2 WM	WFFG Doppel-Wandantenne	
K WFFG-2A 1.8	Floor Loop WiFi 2.A-180	
K WFFG-2A 3.0	Floor Loop WiFi 2.A-300	
K WFFG-2A 3.6	Floor Loop WiFi 2.A-360	
WG WFFGCB	Floor Guard Controller	
FG Hybrid	Hybrid Add-on Accessoires	
WG WFFG58	Floor Guard antenna (mit tuning box)	
WG WFFG2A 6	Floor Loop Antenne 180 x 90 cm	
WG WFFG2A 10	Floor Loop Antenne 3000 x 90 cm	
WG WFFG2A 12	Floor Loop Antenne 360 x 90 cm	
WG TA WF	Turbo Antenne zu Wifi Systemen	
Komponenten:	Abmessungen:	Gewicht
WiFi Control Box		
Mounting plate:	440 x 330 x 85 mm	0,5 kg
System Controller:	380 x 140 x 70mm	2,4 kg
SPS power supply:	110 x 138 x 80 mm	3,1 kg
Hybrid cable:	Diameter 8mm	
Adapter / Tuning-Box:	240 x 190 x 85 mm	1,1 kg
Floor antenna:	1500 x 400 x 28 mm	5,0 kg
Turbo Antenne	200 x 36 x 41 mm	0,5 kg
Hybrid cable:	Diameter 8mm	
Maximale Kabellänge:		
Antenne zu Adapter Box	<6 m	
Hybrid Loop zu Adapter Box	< 2 m	
Adapter Box zu Ccontroller	<15 m	
Controller zu SPS Netzteil	<80 m with WG EA-Type 2 cable	

**Detection and recommended maximum exit widths:**

**The better the labels, the better the detection performance.**

Our Floor Guard Hybrid and Sky Guard systems are designed to work with all types of labels, including the smallest adhesive labels.

Pure floor antenna systems (Floor Guard and Floor Loop) can be placed side by side in any number. For these systems that only send and receive from the floor, we recommend using WG Super Pencil or High Sensitivity 4-Alarm Labels. Minimum distance between multiple Sky Guard or Hybrid systems: 100 cm.

Labels of lower performance achieve lower detection heights, as the influence of metal in the floor cannot be reliably determined in advance. To avoid alarms caused by labels in close proximity to the antennas, a safety field of approximately 40 - 45% of the passage width should be maintained on all sides.

AM loss prevention systems are radio systems operating at the approved operating frequency of 58 KHz. Devices in the vicinity that are not shielded or do not comply with current technology standards (EN 300330 / EN 301 489-3) may cause interference and negatively affect system performance. Adjustments may be necessary after changes to the environmental conditions.

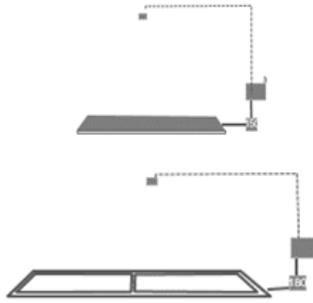
Floor Guard Hybrid		
	Empfohlene Etiketten:	Empfohlene Durchgangsbreiten:
	alle Etiketten	bis zu 250 cm Durchgangsbreite mit APX Klebeetiketten. Mit stärkeren Ferrit Etiketten (ohne Klebesicherungen) bis zu 3,5 m
Sky Guard		
	Empfohlene Etiketten:	Empfohlene Durchgangsbreiten:
	alle Etiketten	bis zu 250 cm Durchgangsbreite mit APX Klebeetiketten. Mit stärkeren Ferrit Etiketten (ohne Klebesicherungen) bis zu 3,5 m
Floor Guard & Floor Loop		
	Empfohlene Etiketten:	Erwartete Detektionshöhe*
	WG Shell & Pencil Tag	110-135 cm Detektionshöhe
	WG Super Pencil Tag	115-145 cm Detektionshöhe
	WG 4-Alarm High Sensitivity Tag	>2m Auslösehöhe
	Durchgangsbreite je Antenne:	150-200 cm



## VISIBLE TAGGING SYSTEMS

False alarm-free\* merchandise security with deterrent effect through elegant transparent pedestals or antennas with integrated advertising space.



## Premier Guard & Premier Pro Guard WiFi

"Sleek, false-alarm-free\* product security in high-transparent acrylic.  
Elegant, unobtrusive antenna design for all industries."

**WG**GLOBAL

## Premier Guard WiFi

## Premier Pro Guard WiFi

"Aesthetic acrylic antenna in a clear design.

Noble, simple, and elegant - the slim, false-alarm-free product security in high-transparent acrylic. Thanks to the latest technology, Premier Guard is particularly powerful despite its compact dimensions of only 38 cm: Passage widths of up to 200 cm with APX adhesive labels and 320 cm with WG Super Pencil hard tags are convincing. The larger Premier Pro antenna (58 cm) even achieves a passage width of 240 cm with APX adhesive labels and up to 380 cm with Super Pencil tags. Extender antennas in the same design are available for narrow passages.

To perfectly blend in with the interior of the store with its modern minimalist design, Premier Guard is available in elegant silver-gray, noble black, clear pure white, or in custom colors. A same-colored plastic base is standard. Optionally, the base cover is also available in stainless steel.

The functions of the WG-WiFi system platform, such as integrated remote maintenance function, jammer detection, or error detection assistant, are on board as standard.

Each Premier Guard WiFi antenna can also be connected to your WiFi network, enabling remote maintenance in case of malfunctions, without any additional infrastructure costs.

Consistent securing with 4-alarm or traditional security labels is crucial for success, in addition to system performance. Security labels also deter potential thieves, directly on the merchandise. The deterrent effect can be supported by signs in visible areas and in fitting rooms."

Um sich mit seinem modernen minimalistischen Design optimal in das



**Spezifikationen Premier Guard / Premier Pro Guard:**

Operating Frequency: 58 kHz, Power Supply: 230 V / AC - 24 V / AC,  
Power Consumption: 35 W, Operating Temperature: 0 ° - 30 ° C

Premier Guard:

Antenna: 1499x380x24 mm, Base: 350x145 mm

Weight: Master 27 kg, Extender 30 kg

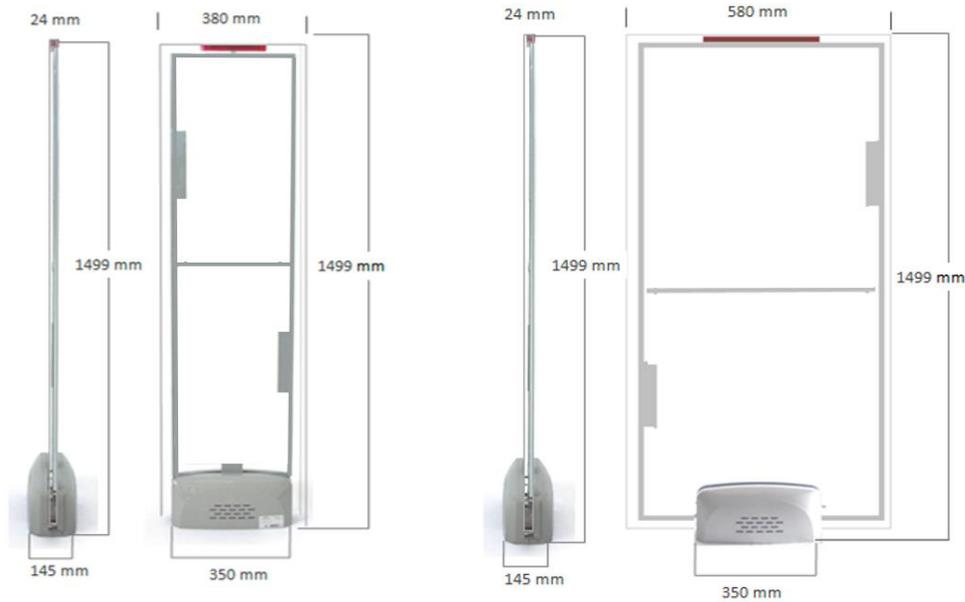



Premier Guard / Premier Pro Guard Installations:



## Ad Guard und AdGuard XL WiFi

False-alarm-free\* acousto-magnetic antenna systems with integrated advertising space.  
Deployed in over 12,000 locations in Germany, including supermarkets and hardware stores.

**WG**GLOBAL

## Ad Guard WiFi

### Ad Guard XL WiFi

**Mechanically extreme robust advertising antenna with the "Lowest Cost of Ownership"!**

Ad Guard is a powerful product security and advertising column in one. The "Ad" stands for the English word Advertisement. Ad Guard is designed for long-term use. Even after years of operation, including in industries with high mechanical stress (such as supermarkets, hardware stores, etc.), the antennas remain fully functional and attractive with updated advertising. The modular design allows for cost-effective refreshments and updates.

The small, sleek Ad Guard antenna with only 33 cm width allows for free passage between the antennas of up to 180 cm with APX adhesive labels or 300 cm with Super Pencil tags, thanks to state-of-the-art signal technology. The larger Ad Guard XL antenna even achieves a passage width of 240 cm with APX adhesive labels and up to 380 cm with Super Pencil tags. Ad Guard is designed for the tough conditions in specialty stores. The robust antenna design withstands inevitable collisions with shopping carts.

The proven functions of the WG-WiFi system platform, such as integrated remote maintenance function, jammer detection, or error detection assistant, are standard on board.

Each Ad Guard WiFi antenna can also be connected to your WiFi network, enabling remote maintenance in case of malfunctions without any additional infrastructure costs.

Consistent securing with 4-alarm or traditional security labels is crucial for success, in addition to system performance. Security labels also deter potential thieves, directly on the merchandise. The deterrent effect can be supported by signs in visible areas and in fitting rooms.gut sichtbaren Stellen und in Umkleidekabinen unterstützt werden.



**Specifications for Ad Guard / Ad Guard XL:**

Operating Frequency: 58 kHz, Power Supply: 230 V / AC - 24 V / AC, Power Consumption: 35 W, Operating Temperature: 0 ° - 30 ° C

Ad Guard:

Weight: 22 kg; Antenna Dimensions: 1655x330x76 mm; Base: 356x120 mm

Advertising Space Format: 1470 x 280 mm

Ad Guard XL:

Weight: 27 kg; Antenna Dimensions: 1655x429x76 mm; Base: 356x120 mm;

Advertising Space Format: 1470 x 425 mm

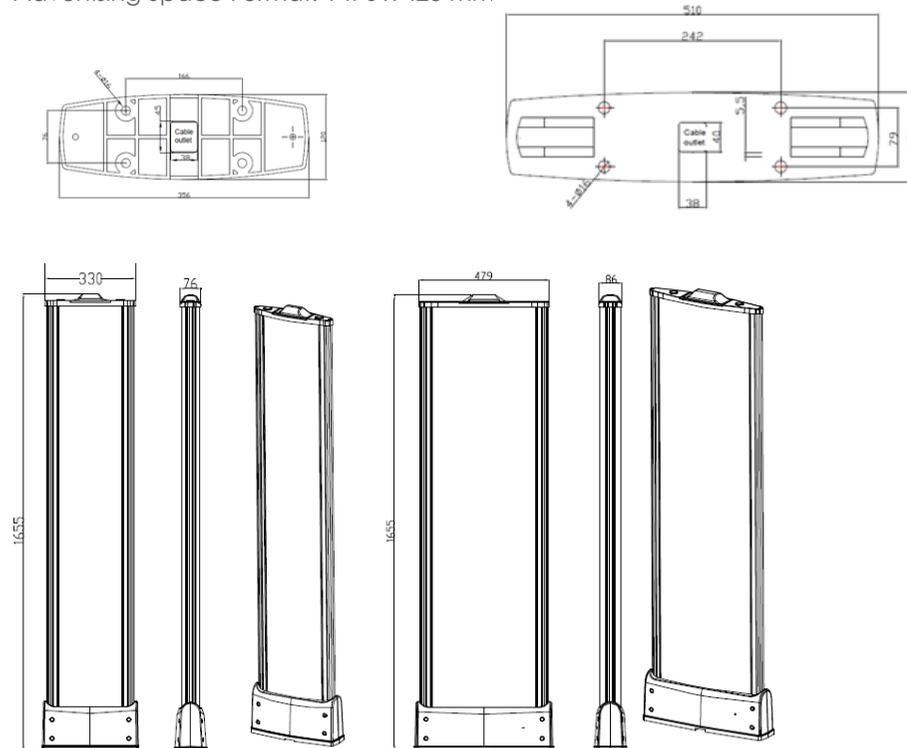



Ad Guard / Ad Guard XL - Installationsbeispiele:

## Installation-description: Premier / Premier Pro / Ad / Ad Guard XL Guard WiFi

Each antenna is powered by an SPS power supply unit with a 24 V voltage. Power supply (3x2.5 mm<sup>2</sup>) via terminal box with its own circuit. All systems in the building and all deactivators on the same phase (L1 recommended. Minimum protection 16 A. Maximum power consumption of 50 W per system, 10/120 W per deactivator (continuous or impulse). In case of a malfunction, for example, continuous alarm due to labels in the field, it is advisable to have a possibility to shut down the system via the SPS power supply accessible to the staff.

The power supply and antenna are connected with the supplied connection cable (9 m). Longer cable lines up to a maximum of 50 m can be realized with EAS-Net cable (or 6x1.5mm) cable. Cable routing is usually done through PG protective pipes in the floor or through cable channels. Ad Guard antennas can also be supplied directly to the ceiling with aluminum risers from the upper antenna cover. Since the antennas are operated with 24 V low voltage, direct laying in grooves drawn in the floor for this purpose is also permitted.

The antennas are attached with threaded bolts drilled into and glued to the floor. Underfloor heating or water pipes in the

installation areas must be reported. To avoid drilling in this area, optional steel floor adhesive kits are available.

The alarm is triggered acoustically and visually directly at the antenna or via an optional, separate alarm unit.

The SPS power supply unit has connection terminals for potential-free contacts to control, for example, a camera system in case of system alarm or jammer alarm. The alarm volume can be adjusted on the SPS. The TX switch assists staff in searching for labels around the antenna. The SPS has a bracket for the standard DIN 46277-3 DIN rail system on the back. Power supplies should therefore be

accessible to staff, e.g., in the switchboard, store manager's office, detective room, or checkout counter. When mounted in the sales area, a closed box (optional) should be used to prevent unauthorized access. A position in the false ceiling is also possible, but an SPS is of course more difficult to reach there.

An integration with the WG EAS Cloud for remote maintenance is done via a customer-side WLAN modem.

Image below:

Two installation examples with different configurations.

Master / Master Konfiguration:

Master / Extender Konfiguration:

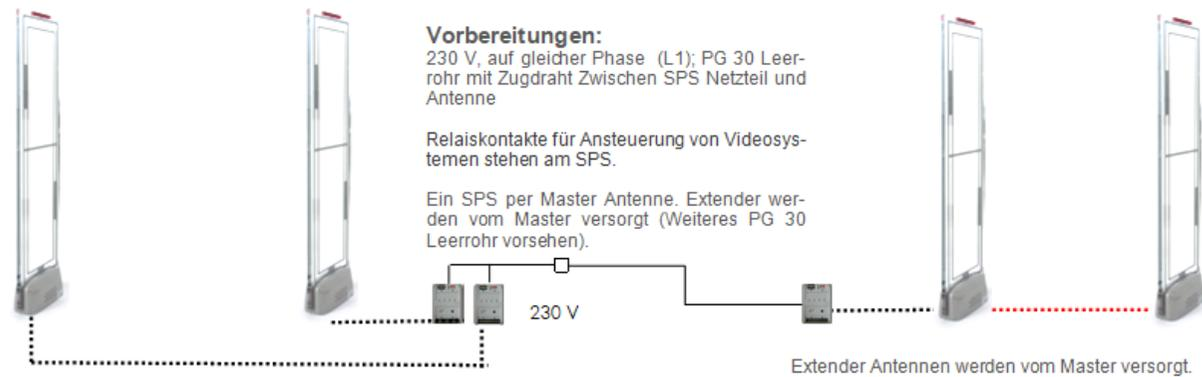

## On-site preparations for Premier / Premier Pro / Ad / Ad Guard XL Systems:

230 V power supply, separately secured, at the location of the SPS power supply unit. Consumption max. 50 W per system.

One 230 V outlet per deactivator, 10/120 W (continuous / peak-pulse). For reliable synchronization, we recommend a fixed connection via terminal box (or reverse-polarity-proof Terko or CEE connectors).

All systems and deactivators in the building on the same phase (L1 recommended).

PVC conduits (30 or 32mm) with draw wire for signal lines and loop antenna according to system diagram (PG conduits).

2-core alarm cable or CAT cable from the system controller to the position of the external alarm console.

### SPS Smart Power Supply:

The universal power supply for WG WiFi product security systems should be accessible to store personnel for troubleshooting purposes:

Functions: (1) System main switch, (2) Power connection (3x2.5 mm<sup>2</sup> cross-section via its own circuit, all systems and deactivators on the same phase (L1 recommended) with the accessories. Minimum protection 16 A. Maximum power consumption of 50 W per system, 10/120 W per deactivator (continuous or impulse). (3) Power voltage switch. (4) TX switch for troubleshooting via phone. (5) Volume control for alarm. (6) Relay connections for alarm control and connection to a video system.

The SPS can be clicked onto standard DIN 46277-3 rails (DIN rail).

To prevent unauthorized access but still make the SPS easily accessible for personnel, we recommend mounting them in transparent plastic boxes.

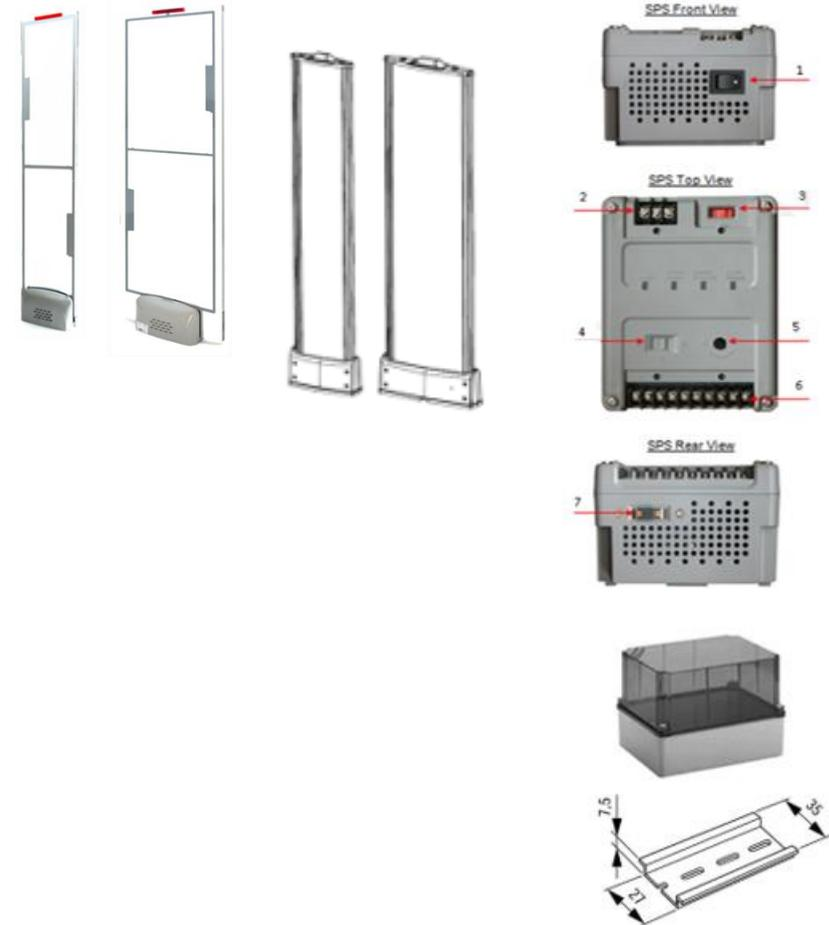

## Recommended Exit Widths:

### Ad Guard / Ad Guard XL / Premier Guard / Premier Pro Guard.

Our product security systems operate on the approved operating frequency of 58 kHz. The maximum passage widths depend on the quality of the security labels used, the antenna performance, and the environmental conditions.

For optimal detection performance, we recommend adhering to the following maximum passage widths.

To avoid alarms caused by labels in the vicinity of the antennas, a safety field of approximately 40-45% of the passage width should be maintained on all sides.

It should be noted that there may be reduced detection performance between transceiver antennas due to system constraints. AM product security systems are radio equipment operating on the approved operating frequency of 58 kHz. Devices in the vicinity that are not shielded or do not comply with the current state of technology (EN 300330 / EN 301 489-3) may cause interference and adversely affect system performance. After changes in environmental conditions, readjustment may be necessary.

System	WG Super Ferrite		WG Ferrite		WG Micro Ferrite		Super Tag / APX Label	
	Durchgangsbreite	Rückfeld	Durchgangsbreite	Rückfeld	Durchgangsbreite	Rückfeld	Durchgangsbreite	Rückfeld
<b>Master Transceiver-Antennen:</b>								
Ad Guard WiFi 	300	150	260	130	180	90	180	90
Premier Guard WiFi 	320	160	280	140	200	100	200	100
Ad Guard XL WiFi 			280					
Premier Pro WiFi 	380	190	320	160	240	120	240	120

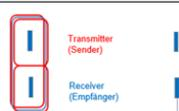
WiFi Master / Slave Sonderkonfigurationen: Ad Guard / Premier Guard Configurations		WG Super Ferrite		WG Ferrite		WG Micro Ferrite		Super Tag DR Label	
 Transmitter (Sender) Receiver (Empfänger)	small	220	110	200	100	160	80	160	80
	XL	240	120	220	110	180	90	190	95
 Transmitter (Sender) Receiver (Empfänger)	small	200	100	160	90	150	75	150	75
	XL	190	95	180	90	140	70	160	80
 Transmitter (Sender) Receiver (Empfänger)	small	170	keep 70 cm distance	140	keep 60 cm distance	130	keep 40 cm distance	120	keep 30 cm distance
	XL	180	keep 80 cm distance	160	keep 70 cm distance	140	keep 50 cm distance	140	keep 40 cm distance

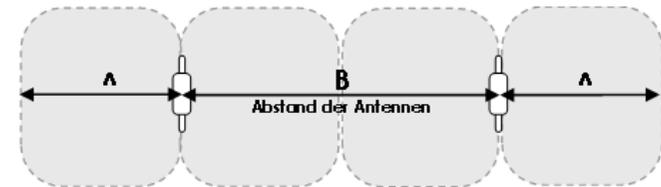



## WAVE High Security Etiketten

Self-alarming security labels with the highest security standard:  
Better product protection and faster handling. Suitable for both AM and RF systems.

## 4-Alarm Wave Tags with Remote-Alarm

The new generation of self-arming WG high-security security labels not only reliably prevents tampering and theft attempts but now also communicates with third-party systems.

In case of an alarm, cameras are activated and a department alarm notifies personnel of a tampering attempt.

**Alarm 1:** The label triggers an alarm if damaged or an attempt is made to remove it. The thief is immediately identified on-site, deterred, and theft is prevented.

**Alarm 2:** The EAS system triggers an alarm as soon as it detects the label.

**Alarm 3:** The EAS system interacts with the label, causing it to emit a loud audible alarm.

**Alarm 4:** Attempting to remove a label with an unauthorized "foreign opener" triggers an alarm.

**Remote Alarm:** The "RA" Alarm: Wave labels transmit an additional radio signal, the "Remote Alarm," to a repeater, which signals optically & acoustically and controls the video system.



Youtube Video



## WAVE Band-it

### Turbo-fast 4-Alarm high security tag Remote Alarm.

"Original packaged products in the fields of cosmetics, consumer electronics, sports, DIY, and spirits are most easily resellable for shoplifters and therefore the most attractive. Band-it is simply pulled over the packaging like a highly flexible rubber band and activated. Sensors detect the firm fit and immediately trigger an alarm in case of manipulation attempts.

Band-it is available in 5 lengths between 10 and 152 cm band length for different packaging sizes and in AM or RF, as well as in 3- or 4-Alarm versions. Remote Alarm is standard. Band-it is most successfully used for packaged goods in the cosmetics, perfumery, electronics, sports, and hardware store product segments.

Size: 69x39x15 mm."

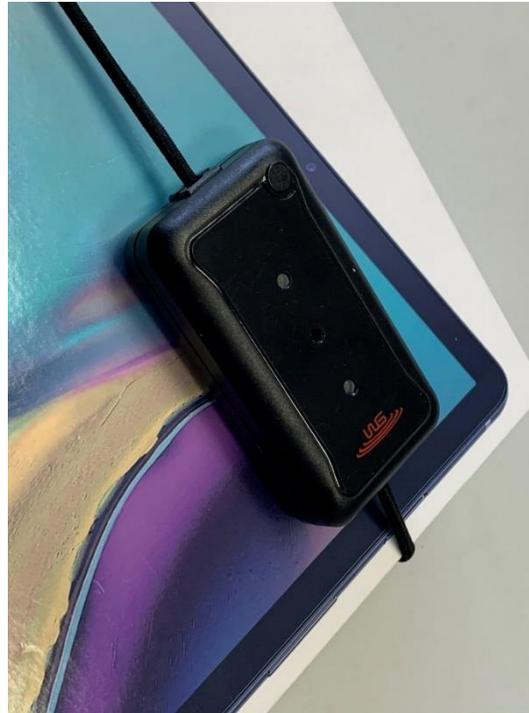

"The renowned LPRC Loss Prevention Research Council in the USA has published a study on Band-it.

CONCLUSION: Employees appreciate the faster handling and reliable function. Customers find the product presentation better. Apprehended shoplifters, on the other hand, were less enthusiastic."

## WAVE Lanyard

### High-security tag with alarm lanyard.

WAVE Lanyard Tag is a 4-alarm label designed to secure a variety of products. Depending on the length of the loop, it is used to secure furs or jackets, as well as bags, tools, technical products, sports equipment, etc.

The integrated steel loop is plastic-coated and integrated into the electronic circuit of the label. A sensor detects manipulation or unauthorized opening. The logic of the label checks during an attempt to open whether a special infrared code is simultaneously transmitted by the opener. If this code is missing or incorrect, an alarm is immediately triggered. Stolen magnetic openers are thus powerless.

Lanyard Tag is available in 3 lengths and in AM or RF, as well as in 3- or 4-alarm versions. Remote alarm is optional.

Standard lengths of the lanyard are:

7 inches = 18 cm

10 inches = 25 cm

48 inches = 122 cm

Size 52x38x26 mm.



## WAVE Pebble

### High-security fashion tag.

Pebble Tag is a 4-alarm label designed to secure garments. Like a conventional security tag, it is attached to the fabric using a pin. Concealed on the inside is a sensor that triggers an alarm in case of manipulation or unauthorized opening. The button is included in the delivery.

The logic of the label checks during an attempt to open whether a special infrared code is simultaneously transmitted by the opener. If this code is missing or incorrect, an alarm is immediately triggered. Stolen magnetic openers are thus powerless. Pebble Tag is available in AM or RF, as well as in 3- or 4-alarm versions. Remote alarm is optional.

For RF users, we have developed a special Pebble variant with a 3D signal module that compensates for the weaknesses inherent in RF technology.

Dimensions: 59x59x21 mm.



## WAVE Ninja Plus Tag

**High-security adhesive tag with package sealing strip.**

Original packaged products in the fields of cosmetics, consumer electronics, sports, DIY, and spirits are most easily resellable for shoplifters and therefore the most attractive.

Ninja is a label variant consisting of a disposable adhesive adapter (carrier) onto which the reusable Ninja tag is clipped. Detaching the label or the carrier immediately triggers an alarm.

Ninja Plus is available in AM or RF, as well as in 3- or 4-alarm versions.

The carriers are available in four versions: without sealing strip, or with a 10, 19, or 48 cm long "sensor stripe".

Dimensions: Label: 63x50x13 mm Carrier: 63x50x1 mm.



## WAVE-Detacher

**Tabletop opener with IR code for Wave 4-alarm labels.**

**Opens Wave labels with IR code and all conventional labels with Superlock closure.**

The Wave IR opener can be directly connected to a USB port of a cash register PC. When the PC is shut down, the IR code function of the opener is deactivated. An attempt to open a Wave security trigger an alarm.

Power supply via USB-A or with the included 230 V USB adapter.

Length of the connection cable: 250 cm

Dimensions:

1500x100x55 mm 1.1 kg

Art. Code: WG WAVE IR DT

WG Wave IR opener tabletop version



## WAVE-Detacher

**Built-in opener with IR code for Wave 4-alarm labels.**

**Opens Wave labels with IR code and all conventional labels with Superlock closure.**

The built-in version features a "manual opening function". Here, by a rotating movement, the Wave IR opener can be taken out of the table-mounted holder and guided to the label.

The Wave IR opener can be directly connected to a USB port of a cash register PC. When the PC is shut down, the IR code function of the opener is deactivated. An attempt to open a Wave security trigger an alarm.

Power supply via USB-A or with the included 230 V USB adapter.

Length of the connection cable: 250 cm

Installation through a cash register table cutout with an 80 mm diameter.

Art. Code:

WG WAVE IR WG Wave IR opener built-in version



## WAVE-Detacher

### **Multi-opener with IR code for Wave 4-alarm labels.**

Opens Wave labels with IR code, all conventional labels with Superlock closure, and additionally, Alpha Safer. The Multi-Detacher can be used as a handheld or tabletop opener. It can be locked and secured against unauthorized use.

The Wave IR opener can be directly connected to a USB port of a cash register PC. When the PC is shut down, the IR code function of the opener is deactivated. An attempt to open a Wave security trigger an alarm.

Power supply via USB-A or with the included 230 V USB adapter.  
Length of the connection cable: 250 cm  
Installation through a cash register table cutout with an 80 mm diameter.

Art. Code:  
WG IR HSLMFD-B4 WG Wave IR Multi  
Opener



## WAVE Remote Alarm

### Alarm Repeater for all "RA" tags

The Alarm Repeater is a remote alarm detector designed to resemble a MiniDome camera. It receives alarm signals from "RA" labels within a detection range of 9-12m radius and displays them visually and audibly. This allows sales or security personnel to respond to an alarming security tag even if it is further away in the store or if loud background music is playing, for example. It features a connection port for video or pager systems, enabling automatic camera functions to be triggered in case of an alarm. Comes complete with a power adapter.

Art. Code:

WG EXA TAG-RA Remote Alarm



**WAVE High-Security-Tags**

Features and Product Codes

	<b>Band-it (Bndt)</b>						
Tag RA 4Bndt58BS-4	4-Alarm Band-it Tag mit "RA-Funktion" und 10 cm (4") Textil/Latexband, für kleinere bis mittlere Kartons mit 15-40 cm Umfang, AM Technologie	<b>AM</b>	✓	✓	✓	✓	✓
Tag RA 4Bndt58BS-10	4-Alarm Band-it Tag mit "RA-Funktion" und 25 cm (10") Textil/Latexband, für mittlere Kartons mit 35-70 cm Umfang, AM Technologie		✓	✓	✓	✓	✓
Tag RA 4Bndt58BS-20	4-Alarm Band-it AM Tag mit "RA-Funktion" und 52 cm (20") langem Latexband		✓	✓	✓	✓	✓
Tag RA 4Bndt58BS-30	4-Alarm Band-it AM Tag mit "RA-Funktion" und 76 cm (30") langem Latexband		✓	✓	✓	✓	✓
Tag RA 4Bndt58BS-60	4-Alarm Band-it AM Tag mit "RA-Funktion" und 152 cm (60") langem Latexband		✓	✓	✓	✓	✓
Tag RA 3Bndt58BS-4	3-Alarm Band-it Tag mit "RA-Funktion" und 10 cm (4") Textil/Latexband, für kleinere bis mittlere Kartons mit 15-40 cm Umfang, AM Technologie	<b>AM</b>	✓	✓	✓	✓	NO
Tag RA 3Bndt58BS-10	3-Alarm Band-it Tag mit "RA-Funktion" und 25 cm (10") Textil/Latexband, für mittlere Kartons mit 35-70 cm Umfang, AM Technologie		✓	✓	✓	✓	
Tag RA 3Bndt58BS-20	3-Alarm Band-it AM Tag mit "RA-Funktion" und 52 cm (20") langem Latexband		✓	✓	✓	✓	
Tag RA 3Bndt58BS-30	3-Alarm Band-it AM Tag mit "RA-Funktion" und 76 cm (30") langem Latexband		✓	✓	✓	✓	
Tag RA 3Bndt58BS-60	3-Alarm Band-it AM Tag mit "RA-Funktion" und 152 cm (60") langem Latexband		✓	✓	✓	✓	
Tag RA 4Bndt8.2BS-4	4-Alarm RF Band-it Tag mit "RA-Funktion" und 10 cm (4") Textil/Latexband, für kleinere bis mittlere Kartons mit 15-40 cm Umfang	<b>RF</b>	✓	✓	✓	✓	✓
Tag RA 4Bndt8.2BS-10	4-Alarm RF Band-it Tag mit "RA-Funktion" und 25 cm (10") Textil/Latexband, für mittlere Kartons mit 35-70 cm Umfang		✓	✓	✓	✓	✓
Tag RA 4Bndt8.2BS-20	4-Alarm RF Band-it Tag mit "RA-Funktion" und 52 cm (20") langem LatexRF Band		✓	✓	✓	✓	✓
Tag RA 4Bndt8.2BS-30	4-Alarm RF Band-it Tag mit "RA-Funktion" und 76 cm (30") langem LatexRF Band		✓	✓	✓	✓	✓
Tag RA 4Bndt8.2BS-60	4-Alarm RF Band-it Tag mit "RA-Funktion" und 152 cm (60") langem LatexRF Band		✓	✓	✓	✓	✓
Tag RA 3Bndt8.2BS-4	3-Alarm Band-it Tag mit "RA-Funktion" und 10 cm (4") Textil/Latexband, für kleinere bis mittlere Kartons mit 15-40 cm Umfang, AM Technologie	<b>RF</b>	✓	✓	✓	✓	NO
Tag RA 3Bndt8.2BS-10	3-Alarm Band-it Tag mit "RA-Funktion" und 25 cm (10") Textil/Latexband, für mittlere Kartons mit 35-70 cm Umfang, AM Technologie		✓	✓	✓	✓	
Tag RA 4Bndt8.2BS-20	3-Alarm RF Band-it Tag mit "RA-Funktion" und 52 cm (20") langem Latexband		✓	✓	✓	✓	
Tag RA 4Bndt8.2BS-30	3-Alarm RF Band-it Tag mit "RA-Funktion" und 76 cm (30") langem Latexband		✓	✓	✓	✓	
Tag RA 4Bndt8.2BS-60	3-Alarm RF Band-it Tag mit "RA-Funktion" und 152 cm (60") langem Latexband		✓	✓	✓	✓	
TAG ACC BndtB	Standplättchen für Band-it Tag.	universal					

 <b>Lanyard (Lyrd, LY)</b>							
Tag RA 4LY 4 58BS	4-Alarm AM Tag with "RA-Function" and 10 cm (4") Lanyard	AM	✓	✓	✓	✓	✓
Tag RA 4LY 48 58BS	4-Alarm Lanyard AM Tag, 48" (120 cm) Lanyard, Black, 58 KHz.		✓	✓	✓	✓	✓
TAG IR Lanyard58 7	4-Alarm Lanyard AM Tag, 7" (18 cm) Lanyard, Black, 58 KHz. AM		NO	✓	✓	✓	✓
TAG IR Lanyard 58HBS-7	4-Alarm Lanyard AM Tag, 7" (18 cm) Lanyard, Black, 58 KHz. AM-HS <i>High Sensitivity</i> , best for Floor Guard / Floor Loop systems		✓	✓	✓	✓	✓
TAG IR Lanyard58 98	4-Alarm Lanyard AM Tag, 98" (240 cm) Lanyard, Black, 58 KHz.		NO	✓	✓	✓	NO
Tag IR/O Lanyard 58 BS 7"	3-Alarm Lanyard AM Tag, 7" (18 cm) Lanyard, Black, 58 KHz.	RF	NO	✓	✓	✓	✓
TAG IR Lanyard8.2 4	4-Alarm Lanyard RF Tag, 4" (10 cm) Lanyard, Black, 8.2 MHz.		NO	✓	✓	✓	✓
TAG IR Lanyard8.2 48	4-Alarm Lanyard RF Tag, 48" (120 cm) Lanyard, Black, 8.2 MHz.		NO	✓	✓	✓	✓
TAG IR Lanyard8.2 80	4-Alarm Lanyard RF Tag, 80" (200 cm) Lanyard, Black, 8.2 MHz.						
 <b>Pebble (PB)</b>							
TAG IR Pebble 58BS	4-Alarm AM Pebble Tag - with Pin-monitoring (Pin Contact), black, Superlock, 58 KHz. AM	AM		✓	✓	✓	✓
TAG IR Pebble 8.2 C GS	4-Alarm RF Pebble Tag - with improved RF detection 8.2 MHz, 3-D coil), Grey, Superlock	RF	X	✓	✓	✓	✓
TAG IR Pebble 8,2 C BS	4-Alarm RF Pebble Tag - with improved RF detection 8.2 MHz, 3-D coil), Black, Superlock	RF					
Pin IR Pebble	Replacement Pin for AM Pebble Tag	AM					
Pin IR Pebble 8.2 C GS	Replacement Pin with 8.2 MHz coil for Pebble tag, Grey	RF					

	<b>Ninja Plus (NJP)</b>						
TAG IR NJP 58 BS	4-Alarm Ninja Plus AM Tag, 58 Khz, to be used with self-adhesive, transparent bases available in multiple versions.	AM	NO	✓	✓	✓	✓
Tag IR/O Ninja 58 PBS	3-Alarm Ninja Plus AM Tag, 58 Khz, to be used with self-adhesive, transparent bases available in multiple versions.	AM	NO	✓	✓	✓	NO
Tag IR NJP 8.2BS	4-Alarm Ninja Plus RF Tag, 8.2 MHz, to be used with self-adhesive, transparent bases available in multiple versions.	RF	NO	✓	✓	✓	✓
Tag-Acc-NJPBS	Ninja Plus Base, transparent, no sensor-stripe (ohne Sensorstreifen)	universal					
Tag-Acc-NJPBS19	Ninja Plus Base, transparent, 48 cm (19") white Sensorstripe	universal					
Tag-Acc-NJPBS7,5	Ninja Plus Base, transparent, 19 cm (7.5") white Sensorstripe	universal					
Tag-Acc-NJPBS4	Ninja Plus Base, transparent, 10 cm (4") white Sensorstripe	universal					



## conventionelle Security Tags

Security tags with extra-strong Super Lock closure and powerful signal ferrite for reliable alarm triggering at an affordable price.

**WG**GLOBAL

## Pencil Tag

Acousto-magnetic hard tags available in three ferrite sizes for medium (Pencil), small (Micro Pencil), or largest passage widths (Super Pencil).

Especially fast cashier handling due to Super Lock closure. Material-friendly thanks to polished, groove-free needle.

Extra-strong magnetic closure; tags can be removed from secured goods using Super-Lock™ openers.

Ferrite precisely tuned to 58 kHz for best detection results.

Dimensions: Super / Pencil / Micro Pencil

Length: 41.9 cm / 49.9 cm / 59.9 cm

Weight: 8g / 9g / 14 g

Art. Codes:

**Pencil** (Standard size)

TAGPEN58-BS = black

TAGPEN58-WS = white

TAGPEN8.2-WS = white\*\*

**Super Pencil** (for largest passage widths or systems with floor antennas (without hybrid loop))

TAGPENS58-GS = gray

TAGPENS58-BS = black

TAGPENS58-WS = white

**Micro Pencil** (for medium and small passage widths)

TAGMPEN58-BS = black

TAGMPEN58-WS = white

\*\*Pencil is also available in white with an 8.2 MHz radio frequency ferrite. It can be used, for example, as a deterrent, as a dummy label in the security field of the EAS antenna, without triggering an alarm there.

Can be used with smooth needles for particularly material-friendly or grooved needles for even higher security.

Use with pin (needle) grooved or completely smooth.



Pins in box à 1000 Stk.

PIN-F = Pin Flat Smooth (glatt)

Optional:

PIN-F-G = Pin Flat Grooved (gerillt)

## Shell Tag & Shell

Acousto-magnetic hard tag for large passage widths featuring special tamper-resistant Shell Tag technology with SuperLock™ security lock. Very secure and simultaneously material-friendly due to the full-surface pressure or weight distribution and the excellent protection of the needle. Included in the delivery are the tag and a special needle (smooth polished). Available in black and gray.

Shell Ink versions feature three additional ink ampoules securely hidden inside the tag. The ink security's breaking point breaks upon tampering. Professionals know that these security measures make it impossible to remove the tag without damaging the goods. Included in the delivery are the tag and a special needle (smooth polished). Micro Shell Tag is a smaller version with a visible ink ampoule.

Dimensions: 54x54x22 mm  
Ferrite precisely tuned to 58 kHz

Standard colors: black or gray  
Ink colors: Red, Yellow, Blue

Art. Codes:

TAG SHELL 58 BS = black  
TAG SHELL 58 GS = gray  
TAG SHELL INK 58 BS = black + ink  
TAG SHELL INK 58 GS = gray + ink

This tag is also available in radio frequency (8.2 MHz and 66 MHz).



## Ink Tag

### Ink security tag

Two-color ink ampoules in a preventive clear case. No electronic function. Can be attached to any hard tag instead of the needle or fastened using a clutch. Breaks upon improper handling, thus deterring shoplifters.

The use of ink labels primarily deters professionals and prevents their return visits.

Size: 40x40x13mm

Art. Codes:  
 Ink label: TAG INKK C  
 Clutch: Clutch CY



## Micro Shell and Micro Shell Ink Tag

Acousto-magnetic hard tag in special tamper-resistant Shell Tag technology with SuperLock™ security lock. Highly secure and simultaneously gentle on materials due to the full-surface pressure distribution and excellent needle protection.

Micro Shell Ink versions feature an additional ink ampoule attached to the label. The break point of the ink security breaks upon manipulation. Professionals know that these security measures make it impossible to remove the label without damaging the goods. Included in the delivery are the label and a smoothly polished special needle.

Dimensions: 45x45x22 mm  
Precisely tuned ferrite at 58 kHz

Standard color: black  
Ink color: red

Art. Codes:  
TAG MSHELL58- BS = black  
TAG MSHELL58- INK BS = black with ink



## Lanyard Tag

Elegant acousto-magnetic hard tag with integrated rubber-coated steel loop for securing bags, hard goods, etc., featuring a magnetic Super Lock closure mechanism. Easier handling, quick and user-friendly, sleek design in black.

Not compatible with D006 detacher.

Size: approx. 52x38x26 mm

Lanyard Length:

9 cm = 3.5 inches

18 cm = 7.0 inches

25 cm = 10 inches

Precisely tuned ferrite at 58 kHz

Art. Codes:

TAG LANYARD 58BS 3.5

(with 3.5-inch loop)

TAG LANYARD 58BS 7

(with 7-inch loop)

TAG LANYARD 58BS 10



## Lanyard

Accessory for securing a variety of hard goods, bags, belts, sports equipment such as rackets, bikes, backpacks, tools, etc.

Material: Steel cable, rubber-coated.

Compatible with all security tags with magnetic and mechanical closures.

Length: 175mm  
Precisely tuned ferrite at 58 kHz

Art. Codes:  
LANYARD AR3P



## Lock Tag

Acousto-magnetic hard tag with magnetic Super Lock™ closure mechanism (can only be removed from secured items with SuperLock™ detachers).

Closure with integrated stainless steel loop.  
Acousto-magnetic component: Ferrite 58 kHz Micro

Compatible with all SuperLock™ detachers, particularly fast and user-friendly at the checkout, sleek design.

Weight: 19 g

Standard color: black

Art. Code:

TAGLOCK58-BS.,

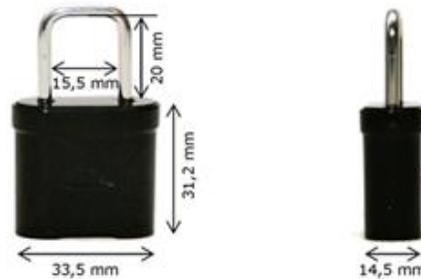
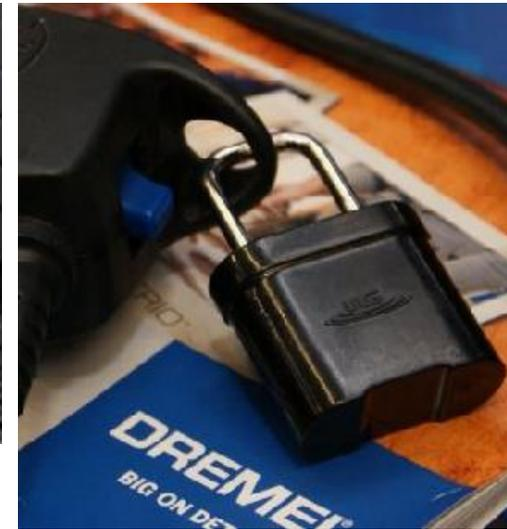

## Bottle-protection

### Crystal Cup

Finally, a universal bottle security device that doesn't add height, doesn't scratch the bottle seal, and still fits into the packaging.

High security against tampering and, with the redesigned Super Lock closure, now also secured against forceful impact.

Quick and easy handling during closure. No tools are required for this. Opening is done with a wear-resistant WG Super Lock magnetic opener.

The standard model fits practically all bottles except for sparkling wine and champagne, which require a larger opening. For a few bottles like Jägermeister and Ballantine's with a particularly short neck, we offer two special sizes.

Available in three versions:  
B006-AMS F Wine / Spirits  
B009/BAMS Champagne

And for bottles with very short necks:  
BT005-AMS Bottle security "Jägermeister"



## Hang Tag

Acoustic-magnetic hard tag for blister packs. Compact label for mounting on many blistered packages. Hang tag mechanically seals the blister packaging and triggers an alarm when passed through acoustic-magnetic anti-theft systems.

The mechanical lock can be unlocked with a SuperLock opener.

Art. Codes:  
Hangtag 58BS



## Security tag for glasses

Acoustic-magnetic hard tag for eyeglass temples with up to 10 mm width and 6 mm thickness. Light gray with patented rubberized closure.

Extremely simple and fast handling thanks to the proven magnetic closure. Easy attachment without tools, Quick removal at the checkout with a standard Super Lock opener. Acoustic-magnetic component: Ferrite 58 kHz

Size: 23 x 24 x 29 mm

Weight: 10 g

Standard color: light gray

Art. Codes:  
WG-TAGAL58



## Security tag for glasses

Acoustic-magnetic hard tag for eyeglass temples with up to 16 mm width and 6 mm thickness. Light gray with patented rubberized closure.

Mechanical closure.

A special mechanical key is required for attachment and removal.

Acoustic-magnetic component: Ferrite 58 kHz

Size: 23 x 24 x 29 mm

Weight: 10 g

Standard color: light gray

Art. Codes:

Glasses Guard = T019/F-AM

Special Opener = K03-AM/RF



## Adhesive Label

Acoustic-magnetic adhesive tag,  
 Manufacturer: Sensormatic.  
 Deactivatable with acoustic-magnetic  
 deactivators.

Acoustic-magnetic component: Dual  
 resonator  
 58 kHz

Size: 45 x 10 x 1.7 mm  
 Weight: approx. 1 g

Delivered in boxes of 5,000 pieces on carrier  
 foil.  
 A4 sheets with 108 labels each.

Standard colors: white, black, Dummy  
 Barcode imprint

Art. Codes:  
 ZLAPXS1 = white  
 ZLAPXS5 = black  
 ZLAPXS2 = Barcode imprint



## Seal-Tag stops wardrobing!

Return fraud, also known as wardrobing, is a significant issue in both brick-and-mortar and online retail.

Ordered or items taken home for trial are worn at an evening event and then returned. Seal-Tag from WG Global addresses this problem.

The Seal-Tag single-use label is attached to the garment along with a prominently displayed information card. Attachment is similar to traditional security tags. When the customer has made their purchase decision, they can remove the tag themselves by lifting the seal ring.

Seal Tag is especially stylish when customized with your own logo.

Dimensions: 62x29x11 mm





## Cash-desk-Accessoires

Deaktivatoren für Labels und Freigabe-Buttons für Tags

**WG**GLOBAL

## Fast Pad Deactivator

### Powerful deactivator for adhesive labels.

Mounting options: horizontal or vertical; tabletop, built-in, or under-counter installation using the included installation bracket.

Operating frequency: 58 kHz  
 Detection height: up to 12 cm  
 Speed: up to 2 labels/sec.  
 Signaling: visual and auditory  
 Operating temperature: 0° - 49° C (32-120°F)  
 at 0-85% humidity  
 Power: 100/120 VAC – 60 Hz  
 220/240 VAC – 50 Hz

Dimensions / Weight:  
 Deactivator: 295 x 280 x 47 mm, 4.5 kg

Installation bracket:  
 Outer dimensions: 320 x 307 x 57 mm, 0.4 kg  
 Cutout: 304 x 289 mm

Controller:  
 275 x 190 x 140 mm, 3.0 kg

Scope of delivery:  
 Deactivator plate  
 Control electronics with key switch, 2 keys  
 Installation bracket for under-counter and built-in installation including cover plate, installation template, connection cable 1.5 m, 230 V power cable  
 Documentation

Art. Code: WGFP58-2

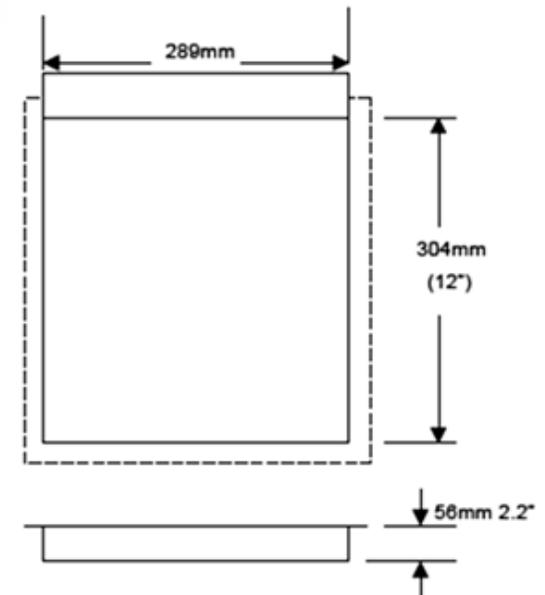
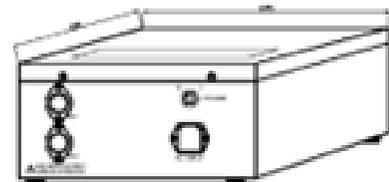

## Fast Pad POS Deactivator

### Powerful Deactivator for Cash Register Installation

Mounting Options: Horizontal or vertical; on-table, built-in, or under-table installation using the installation bracket (included)

Operating Frequency: 58 kHz  
 Detection Height: Up to 12 cm  
 Speed: Up to 2 labels / sec.  
 Signaling: Visual and auditory  
 Operating Temperature: 0° - 49° C (32-120°F)  
 at 0-85% humidity  
 Power: 100/120 VAC – 60 Hz, 220/240 VAC – 50 Hz

Dimensions / Weight:  
 Deactivator: 295 x 280 x 47 mm, 4.5 kg  
 Installation bracket:  
 Outer dimensions: 320 x 307 x 57 mm, 0.4 kg  
 Cutout: 304 x 289 mm  
 Controller: 275 x 190 x 140 mm, 3.0 kg

Delivery Content:  
 Deactivator plate, Control electronics with key switch, 2 keys  
 Installation bracket, Cover plate, 230 V power cable

Art. Code: WGFP58-POS

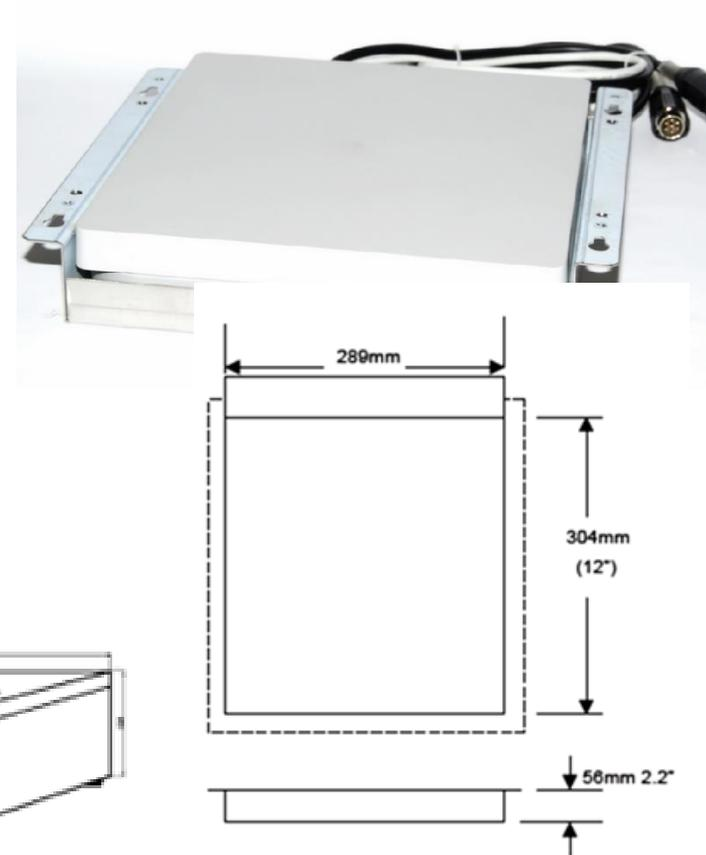

## Stealth Pad Deactivator

### Compact, High-Performance Deactivator

Mounting Options: Horizontal or vertical; on-table, built-in, or under-table installation using the installation bracket (included)

Operating Frequency: 58 kHz  
 Detection Height: Up to 12 cm  
 Speed: Up to 2 labels / sec.  
 Signaling: Visual and auditory  
 Operating Temperature: 0° - 49° C (32-120°F)  
 at 0-85% humidity  
 Power: 100/120 VAC – 60 Hz, 220/240 VAC – 50 Hz

Dimensions / Weight:  
 Deactivator: 188.1 x 170 x 80.4 mm, 3.0 kg  
 Under-table or built-in bracket:  
 Outer dimensions: 235 x 200 x 86.6 mm, 0.24 kg  
 Cutout: 205 x 185 mm  
 Controller: 275 x 190 x 140 mm, 3.0 kg

Scope of delivery:  
 Deactivator plate  
 Control electronics with key switch, 2 keys  
 Installation bracket for under-counter and built-in installation including cover plate, installation template, connection cable 1.5 m, 230 V power cable  
 Documentation

Art. Code: WGSP58

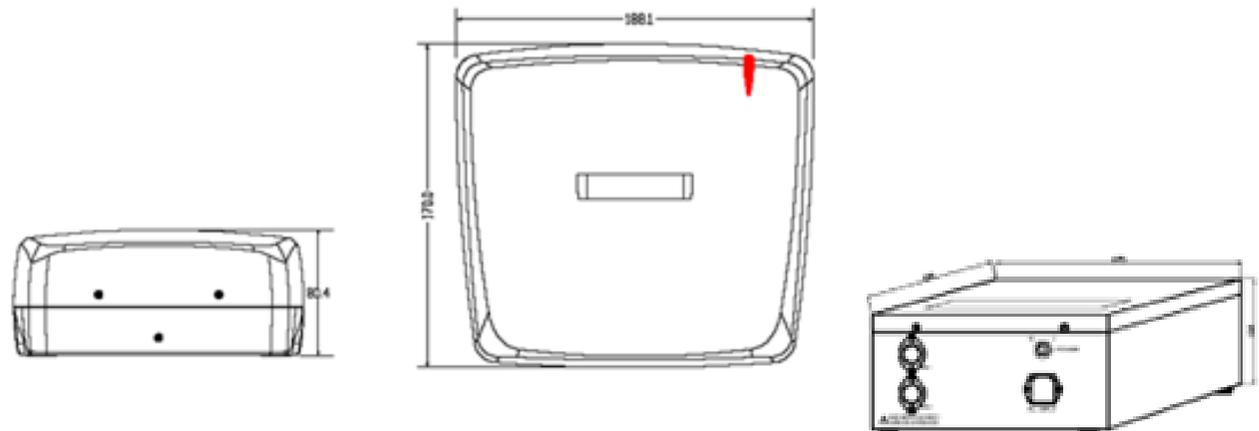

## Stealth Pad II Deactivator

### Compact, High-Performance Deactivator

Mounting Options: Built-in, horizontally or vertically; housing flange covers the cutout.

Operating Frequency: 58 kHz  
 Detection Height: Up to 12 cm  
 Speed: Up to 2 labels / sec.  
 Signaling: Visual and auditory  
 Operating Temperature: 0° - 49° C (32-120°F)  
 at 0-85% humidity  
 Power: 100/120 VAC – 60 Hz, 220/240 VAC – 50 Hz

Dimensions / Weight:  
 Deactivator: 236 x 180 x 65 mm, 3.0 kg  
 Cutout: 215 x 165 mm  
 Controller: 275 x 190 x 140 mm, 3.0 kg

Included in Delivery:  
 Deactivator plate  
 Control electronics with key switch, 2 keys  
 Mounting bracket for under-mount and built-in installation including cover plate, installation template, connection cable 1.5 m, 230 V power cable, Dokumentation

Art. Code: WGSP58 II

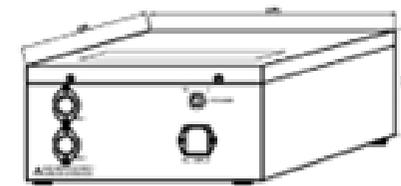

## Lynx Deactivator

### Slim Design Deactivator

Mounting Options: Built-in horizontally or vertically, housing flange covers the cutout.

Operating Frequency: 58 kHz

Detection Height: Up to 12 cm

Speed: Up to 6 labels / sec.

Signaling: Visual and auditory

Operating Temperature: 0° - 49° C (32-120°F) at 0-85% humidity

Power: 100/120 VAC – 60 Hz, 220/240 VAC – 50 Hz

Dimensions / Weight:

Deactivator: 188.1 x 170 x 80.4 mm, 3.0 kg

Under-table or built-in mounting bracket

Outer dimensions: 235 x 200 x 86.6 mm, 0.24 kg

Cutout: 205 x 185 mm

Controller: 275 x 190 x 140 mm, 3.0 kg

Scope of delivery:

Deactivator plate

Control electronics with key switch, 2 keys

Installation bracket for under-counter and built-in installation including cover plate, installation template, connection cable 1.5 m,

230 V power cable

Documentation

Art. Code:

WG Lynx

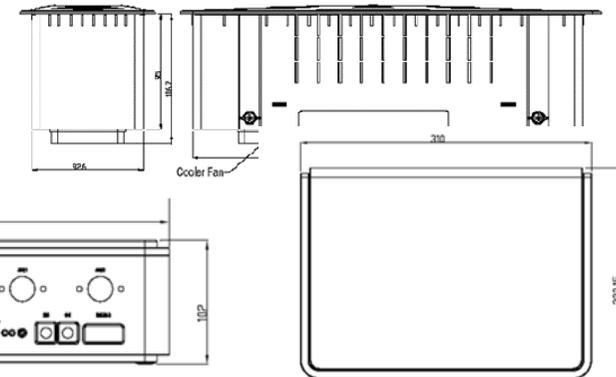
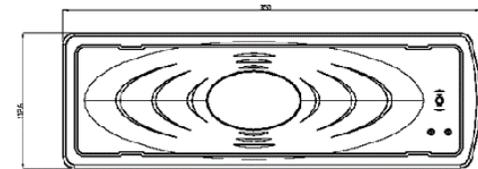

## Nano Pad Deaktivator

### Kostengünstiger Deaktivator

### Cost-Effective Deactivator

Nano-Pad is a cost-effective deactivator, offering an ideal solution for retailers where high deactivation speed is not a priority or where cash registers have limited space, yet they expect the same reliable deactivation for all their merchandise.

Nano-Pad is designed to work best with APX-Etiketten®.

The Nano-Pad comes with a removable, flush mounting kit, allowing it to be used in either configuration. It can be installed as a tabletop or flush-mounted version, depending on what best suits the checkout counter.

Utilizing the latest deactivation technology, the Nano-Pad has become not only smaller but also consumes less energy. Therefore, it only requires a small power supply, no longer needing a large controller.

The Nano-Pad fits perfectly in fashion stores, boutiques, leather and luggage shops, perfumeries, and many others.

Operating Frequency: 58 kHz  
 Detection Height: Up to 12 cm  
 Speed: Up to 6 labels / sec.  
 Signaling: Visual and auditory

Operating Temperature: 0° - 49° C (32-120°F)  
 at 85% humidity  
 Power: 100-240 VAC – 50/60 Hz

Maße mit Montagekit: 23.5\*19\*5.5 cm  
 Deaktivator: 21\*16.5\*4,7 cm  
 Gewicht: 2,3Kg;  
 Verpackung: 27\*27\*15cm  
 Statusanzeige: Green and red LED's.  
 Certifications: CE

Stromaufnahme: 18VDC, 1.7A

Art. Code: WG NP58-1



## Doublechecker

### No More Forgotten Labels.

A control device to automatically detect labels that have not been removed when handing over the merchandise to the customer. This helps prevent unwanted alarms and the wrongful suspicion of honest customers.

It can be operated on the checkout counter or integrated into/underneath the checkout counter.

Operating Frequency: 58 kHz

Detection Height: Up to 12 cm

Signaling: Visual and auditory

Operating Temperature: 0° - 49° C (32-120°F)  
at 0-85% humidity

Power: 100/120 VAC – 60 Hz, 220/240 VAC – 50 Hz

Dimensions: 34 x 24 x 2.5 cm, 0.7 kg..

Art. Code: WG DC58-1

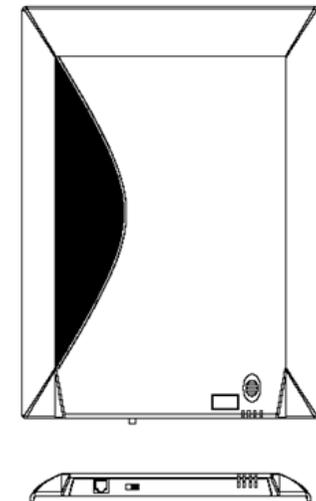

## Magnetdetacherr

**For conventional Security Tags**

DSM tabletop-Economy detacher for Super Lock tags  
Art. Code: WG-DSM2.35/1.25

---



Superlock flush mount releaser, metal, cutout 60 mm, cover 72mm  
Art. Code: D008

---



Superlock releaser, flush mount.  
Art. Code: D702 black

---



Superlock handreleaser with spiral-cable to be fixed at till.Art.  
Code D905-II

---



Superlock Hand opener with holder; Can be fixed to the table  
(desktop) and removed from it, used as a hand opener on a spiral  
cord. Lockable.  
Article number: D049

---



Multi Detacher for all conventional tags with Super Lock magnetic  
closure and Alpha Safers.  
Article code: WG HSLMFD-8

---



Shell-Tag Hyperlock Detacher (14000 Gauss), chrome with optional black cover cap.  
The 14,000 Gauss magnetic force is oriented to open even the strongest WG Shell Tags.  
Built-in version (70 mm).  
Article code: D207

---



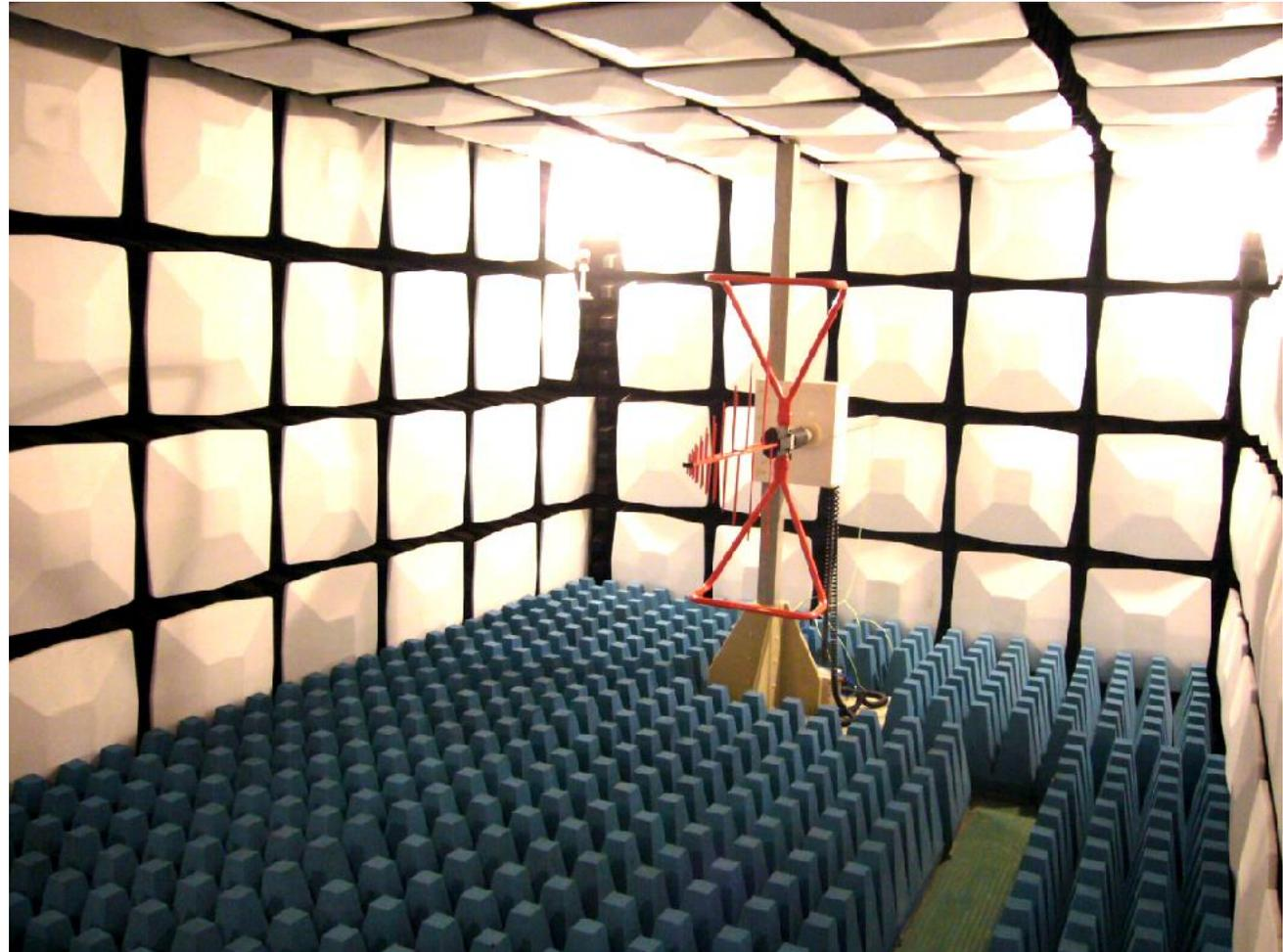

## System and Alarm Accessories

Alarm sounders, special antennas, antenna accessories

**WG**GLOBAL

## EXA-G-II

### External Alarm Console

External alarm console for connection to WG EAS systems WG-EXA-G.

This alarm console is typically used with invisible security systems such as WG Floor Guard or WG Sky Guard. The alarm is displayed optically and acoustically directly at the exit. Since the system controllers of these systems are usually mounted hidden in the false ceiling or behind a revision flap in the store design, the alarm at the controller would be poorly audible and spatial assignment difficult.

In normal operation, the alarm console looks discreetly like a smoke detector. In case of an alarm, a warning tone sounds, and the alarm unit flashes red or optionally blue.

Installation is flush with the ceiling. For adjusting the volume or alarm tone, the alarm unit is released from the installation box using a twist-lock and then reinserted. Connection can be made either to the system controller or a Smart Power Supply. For the connection, we recommend using a CAT 6 cable.

Cutout: 100 mm diameter  
 Cover ring: 147 mm diameter  
 Alarm unit: 90 mm diameter

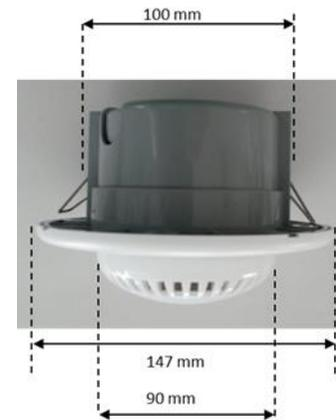

## EXA-G-III

### External Ceiling-Mounted Alarm Console

External alarm console compatible with all WG EAS systems.

This alarm console is typically used with invisible security systems such as WG Floor Guard or WG Sky Guard. The alarm is displayed optically and acoustically directly at the exit.

Since the system controllers of these systems are usually mounted hidden in the false ceiling or behind a revision flap in the store design, the alarm at the controller would be poorly audible, and spatial assignment difficult.

The discreet design of the EXA-G III allows it to blend seamlessly into its surroundings.

Installation is recessed into a 55 mm diameter cutout in the ceiling.

Connection is made to the SPS Power Supply via standard two-pole signal cable or CAT5/CAT6 cable.

Cutout: 55 mm diameter  
Cover Ring: 75 mm  
Alarm Unit Depth: 53 mm



	EXA-G	EXA-GII	EXA-GIII
			
Audio Alarm	✓	✓	✓
Different alarm tones	3	>25	no
Recordable alarm speech	✓	no	no
Adjustable volume	✓	✓	✓ <small>at control box</small>
Visual Alarm	✓	✓	no
Counter	✓	no	no
Wall mount	✓	no	no
ceiling flush mount	no	✓	✓

## EXA-G

### Digital External Alarm Console

External digital alarm console for connection to WG EAS systems WG-EXA-G.

This alarm console allows for an additional acoustic alarm to be triggered in more distant rooms or is used wherever the standard alarm is not sufficient due to background music or other ambient noise.

WG-EXA-G also offers a selection of different alarm tones, The possibility of voice recording for individual messages in case of alarm. Display with alarm counter.

height 210 mm  
width 152 mm  
depth 30 mm  
10 VAC, 50/60 Hz



## EXA-FPSP

### External Signal Console for Deactivators

External alarm console for connection to WG deactivators WG-EXA-FPSP.

This alarm console allows for an additional acoustic signal to be emitted wherever the standard signal is not sufficient due to background music or other ambient noise.

WG-EXA-FPSP für Anschluss an WG-Deaktivatoren

height 99 mm  
width 69 mm  
depth 38 mm



## FRANZ- smart Pager Wireless Paging Alert System

Whether it's an EAS alarm, a remote alarm from a security tag, or a jammer alarm, or if you want to page important information reliably and quickly to responsible individuals.

FRANZ, the intelligent paging system, automatically transmits the message. Signaling is done simultaneously through vibration and in plain text.

Jedem FRANZ Pager können bis zu 32 verschiedene Meldungen zugeordnet werden. Die Signale können automatisch erzeugt werden, z.B. durch ein EAS-System, ein selbstalarmierendes Etikett mit „RA“ Funktion oder manuell mittels einer Ruffaste z.B. als Kundenservice.

Die Möglichkeiten sind nahezu unbegrenzt. Ein Kunde sucht nach einem Experten, der ihm bei der Entscheidung hilft. Durch Drücken eines FRANZ Rufknopfes am Regal kann er Hilfe anfordern. Der Ruf geht in Klartext nur an jene Pager, die für das Thema zuständig sind. Sobald eine Zuständige Person den Ruf quittiert, werden alle anderen informiert, dass die Aufgabe angenommen wurde.

Reichweiten im freien Feld bis zu 200 m (Pager), 170 m (Alarm-Knopf), bzw. 300 m (Repeater)

FRANZ Pager:  
Power supply: Li-Ion battery 3.7V / 750mAh  
Standby time: approx. 48 hours  
Dimensions: approx. L90 x W60 x H12mm  
Weight: approx. 70g

FRANZ Charging Station:  
Can be cascaded up to 8 times, with plug-in power supply (230V 5VDC, 3A)  
Dimensions: approx. D75 x W66 x H24mm

FRANZ Wireless Paging Alarm Module for connection to external devices, e.g., an EAS system.  
Via a relay contact. UHF transmitter-receiver with automatic call retry and 3V lithium battery CR2032 for approx. 50,000 calls, programmable display text.  
Dimensions: approx. L76 x W76 x H12mm  
Weight: approx. 50g

FRANZ Starter Set:  
1x Pager,  
1x Charging Station with power supply,  
1x Alarm Module

Art. Code: FRANZ START



---

## FRANZ-Mini Pager

Additional Pager inkl. Charging-bay-extension: ca. T75 x B66 x H24mm

Art. Code: FRANZ ERW



---

## FRANZ Funk-Ruf Alarmmodul

Flat, for external door contact with control LED (transmit-active) UHF transmitter-receiver with automatic call retry and 3V lithium battery CR2032 for approx. 50,000 calls. Art. Code: FRANZ AL



---

## FRANZ Funk-Ruf-Button

For flush-mount installation with control LED, UHF transmitter-receiver, automatic call retry, and 3V lithium battery CR2032 for approximately 50,000 calls. Installation dimensions: approximately 30 x 14mm; Outer diameter: approximately 35mm. Bell icon. Special versions available from 100 pieces.



Art. Code: FRANZ RUF

---

## FRANZ Repeater

Includes power supply for extending distances. Receives and transmits FRANZ signals after an adjustable delay. Up to 4 of these repeaters can be cascaded. If no transmitter is within range, the repeater repeats until successful delivery. Power supply: 12Vdc / approx. 0.1A. Dimensions: approx. L142 x W58 x T24mm.



Art. Code: FRANZ REP.

---

## Bunper

Our Ad Guard antennas withstand (almost) everything.

In some areas of retail, especially where shopping carts are heavily loaded or forklifts operate, additional protection is advisable to prevent mechanical damage to the antennas.



## Turbo Antenne

Additional antenna to enhance detection performance in critical situations or as a small counter antenna in single-antenna systems.

Art. Code: WG TA58WF<



# WiFi Remote Maintenance & Diagnostics

**at no additional cost, standard!**

Our retail security systems are extremely reliable and built for use in modern retail infrastructure. Essentially, they are maintenance-free. Preventive maintenance is not practical; however, intervention is necessary in the event of a malfunction.

But even the best technology can fail, or if environmental conditions change, recalibration or synchronization may be required. WG EAS Cloud, the free Remote Tuning & Diagnostic functionality, is standard in our Wi-Fi antennas.

The systems utilize existing WiFi networks to connect to the WG Cloud. There is no need for investment in costly infrastructure. Remote access to the system is only provided in case of a malfunction, to retune, synchronize, or support store personnel. Naturally, it complies with GDPR regulations.

Travel costs are eliminated, and the response time for troubleshooting is reduced. A clear advantage for our customers..

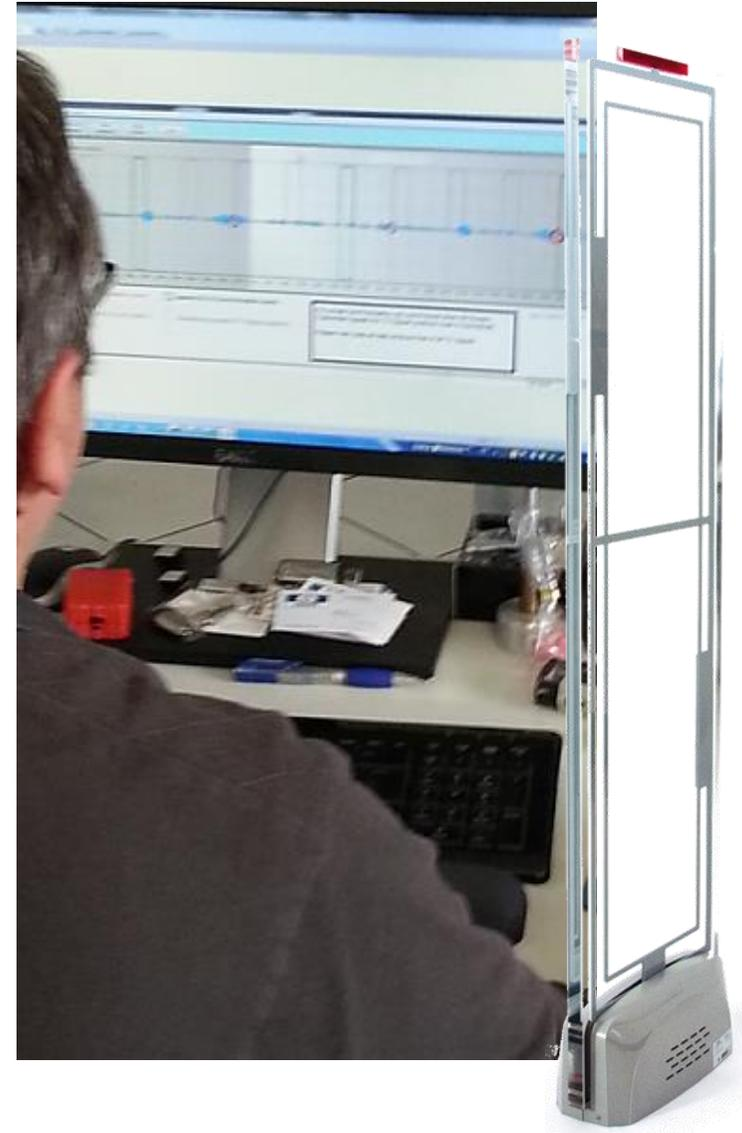

**Disclaimer**

While every effort has been made to ensure the accuracy of this catalog, errors cannot be completely ruled out. WG Global GmbH assumes no responsibility or liability for damages arising from the use of the information contained herein. Furthermore, WG Global GmbH reserves the right to change descriptions and specifications without prior notice.

**Copyright Notice**

All content of this catalog, including but not limited to design, text, and software, technical drawings, configurations, graphics, and other files, are the property of WG Global GmbH or WG Security Products Inc. The content may not be modified or copied without written permission.

\*The WG system algorithm detects label signals and thus prevents false alarms caused by carried items.



- False alarm-free\* tagging systems
- Video surveillance with AI
- Video management systems for branch operations
- Public signage advertising monitor systems
- Sales aids
- Batteryless electronic price tags

WG GLOBAL GmbH.  
Sägewerkstraße 3  
D-83416 Surheim

[www.wgglobal.eu](http://www.wgglobal.eu)

+49 8654 7715-0

Info@wgglobal.eu